

A large, bold, lime green letter 'B' with rounded corners and a thick stroke. It is centered on a dark gray background. The letter is partially overlaid by a white outline of a large, rounded 'B' shape that frames the entire page. There are also some white geometric shapes, like a triangle and a rectangle, scattered around the letter.

**BON·EL**

**CATALOGO • LISTINO**  
**CATALOGUE • PRICE LIST**

## Indice generale - *General index*

CATENACCI door bolts	5
CERNIERE hinges	21
MANIGLIONI pull handles	53
MANIGLIE door handles	63
MANIGLIE A INCASSO sliding door	71
POMOLI knobs	81
BATTENTI door knockers	87
ACCESSORI PER PORTE E FINESTRE accessories for doors and windows	91
POMOLINI E MANIGLIETTE furniture knobs and handles	103
SUPPORTI CORRIMANO, ACCESSORI PER RINGHIERE supports handrail, accessories for railings	115
COPRI INTERRUTTORI, CAMPANELLI, BUCHE PER LETTERE, TARGHE switch covers, door bells, letter plates, plates	121
REGGIMENSOLE brackets	127
MINUTERIA small parts	129

# INDICE ALFANUMERICO

CODICE ARTICOLO	PAGINA
A	62
B	62
R 861	26
R 861 P	26
R 861 PRG	26
R 862	27
R 862 P	27
R 862 PRG	27
1	13
1 B	14
1 C	14
1 D	14
1 G	15
2	16
3	17
4	41
5	41
6	41
7	41
8	42
9	42
10	47
11	48
12	48
13	45
13 B	45
14	45
15	46
16	46
17	137
18	44
19	44
19 C	44
20	15
20 B	15
20 C	16
21	43
21 C	43
22	43
22 C	44
24	137
25	46
26	46
27	94
29	44
30	45
30 B	36
31	17
32	17
33	19
33 C	19
34	96
35	101
36	99
37	100
38	101
40	92
41	93
42	94
43	112
44	113
45	113
46	130
47	130
48	131
49	132

CODICE ARTICOLO	PAGINA
50	137
51	94
53	98
54	116
54 B	116
54 C	116
54 D	116
54 E	117
54 F	117
54 H	117
55	34
55 B	34
56	34
56 B	35
57	35
58	35
59	35
59 B	36
60	36
61	36
62	37
63	37
64	37
67	122
67 B	122
67 C	123
70	100
71	96
71 B	96
72	16
73	88
74	88
75	88
76	89
77	82
79	25
79 P	25
79 PRG	25
81	40
82	104
83	104
85	30
85	30
86	31
86	30
86 F	32
86 G	31
86 Z	32
87	100
88	133
89	131
90	20
92	92
92 B	92
92 C	92
94	104
95	47
96	47
96 B	47
98	94
101	54
102	54
105	135
106	132
107	131
108	104

CODICE ARTICOLO	PAGINA
109	82
110	82
114	83
115	83
116	132
117	54
120	133
121	133
121	132
122	133
135	18
136	18
137	99
150	48
160	32
165	33
170	33
171	33
172	33
173	45
175	119
175 B	119
175 C	120
175 T	119
180	132
185	133
186	93
190	6
200	6
200 V	6
201	104
202	105
203	105
204	105
205	105
206	105
207	106
208	106
210	106
210	7
210 S	9
220	7
220 E	8
220 L	8
220 LE	9
220 P	12
220 S	10
229	20
230	130
231	130
232	137
277	98
288	95
302	134
303	134
304	134
310	89
320	89
331	90
340	83
350	84
403	89
404	88
407	134
423	135
450	97

CODICE ARTICOLO	PAGINA
451	97
455	98
460	98
461	99
500	122
501	122
597	58
650	57
655	57
690	58
691	58
700	93
701	93
735	107
740	107
750	107
755	106
768	106
770	107
800	72
800 F	72
801	72
801 F	72
808	49
840	48
860	40
861	22
861 GP	22
861 GPRG	23
861 P	22
861 PR	23
861 PRG	23
862	24
862 P	24
862 PRG	24
863	37
864	38
865	38
866	38
867	38
868	31
869	34
910	123
911	136
913	13
999	97
1111	84
1142	59
1182	138
1230	10
1230 S	11
1230 S SPECIAL	12
1240	11
1260	64
1270	64
1285	51
1295	51
1300	64
1320	65
1330	65
1340	65
1370	66
1380	66
1400	66
1410	67
1440	68

CODICE ARTICOLO	PAGINA
1448	69
1700	126
1701	126
1703	74
1704	85
1706	85
2002	73
2002 Q	73
2004	123
2005	123
2006	135
2007	135
2008	118
2008 B	118
2008 C	118
2008 D	118
2009 B	119
2016	84
2017	55
2017 B	55
2018	55
2018 B	
2019	101
2019 B	101
2019 C	102
2020	125
2020 B	133
2023	112
2025	124
2026	124
2027	124
2029	112
2033	12
2034	108
2034 B	110
2035	109
2036	108
2036 B	111
2037	109
2038	108
2038 B	111
2039	110
2040	108
2041	110
2041 B	111
2042	109
2043	109
2043 B	111
2044	110
2045	108
2046	125
2046	109
2046 B	111
2047	125
2050	49
2051	13
2052	110
2054	73
2055	73
2056	73
2057	74
2058	74
2058 Q	75
2058 V	75
2059	75
2059 Q	76

CODICE ARTICOLO	PAGINA
2060	76
2064	90
2067	85
2068	56
2069	56
2070	56
2071	57
2072	69
2073	69
2074	69
2083	95
2085	128
2088	128
2089	95
2090	59
2091	59
2092	59
2093	60
2094	60
2095	60
2096	95
2097	138
2098	138
2410	62
2500	39
2606	40
2607	40
2609	60
2610	61
2611	61
2612	61
2613	61
2614	67
2615	68
2615	67
2620	40
3235	136
3238	136
3249	136
3260 B	111
3261	112
3276	77
3281	77
3282	77
3316	50
3317	50
3318	50
3322	49
3323	50
3338	49
3350	42
3351	42
3352	43
3370	51
3374	51
3497	39
3498	39
3499	128
3500	39
4730	78
4735	78
4740	79
7401	77
7402	78
7504	76





**CATENACCI**  
*door bolts*

**190** CATENACCIO VERTICALE CON BLOCCO DI SICUREZZA E PROTEZIONE SCORRIMENTO INTERNO IN NYLON  
 VERTICAL BOLT WITH SECURITY LOCK AND INTERNAL SLIDING LOCK IN NYLON



INC. COMPRESI CON SPESSORI  
 1 m • 2 m • 3 m • 4 m

mm	PEZZI	OLV	OBV	OCR	CRSAT	ANT	OBGR	BRYES
200	2	28,88	28,88	36,66	37,50	30,55	31,00	31,00
250	2	30,06	30,06	39,42	40,00	31,85	32,40	32,40
300	2	33,67	33,67	42,90	43,50	35,75	36,50	36,50
400	2	34,90	34,90	45,90	46,50	37,50	37,90	37,90
500	2	38,07	38,07	48,90	49,50	40,00	40,50	40,50
INC	6	7,20	7,20	7,80	8,00	7,35	7,50	7,50



**200** CATENACCIO ORIZZONTALE TONDO GIGANTE mm 43 CORSOIO Ø mm 15  
 BIG ROUND HORIZONTAL BOLT mm 43 SLIDER Ø mm 15



mm	PEZZI	OLV	OBV	OCR	CRSAT	OBGR
250	2	48,00	48,00	56,00	57,00	48,50
300	2	58,00	58,00	66,00	67,00	58,50
400	2	76,00	76,00	85,00	86,00	76,50



**200 V** CATENACCIO VERTICALE TONDO GIGANTE mm 43 CORSOIO Ø mm 15  
 BIG ROUND VERTICAL BOLT mm 43 SLIDER Ø mm 15

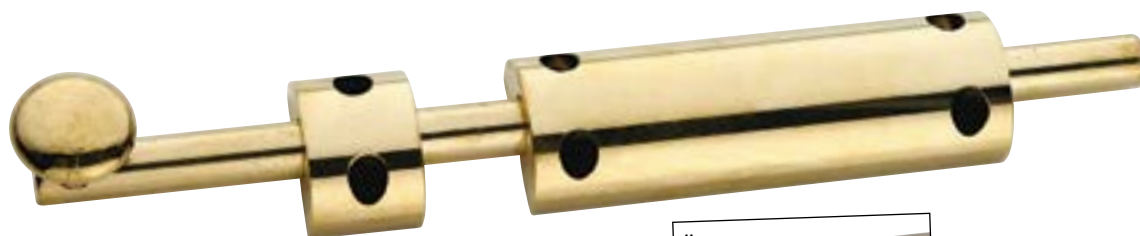

\* A RICHIESTA È POSSIBILE AVERE IL BLOCCO DI SICUREZZA TIPO "E" CON UNA MAGGIORAZIONE DI PREZZO PARI A € 6,00.  
 ON REQUEST IT IS POSSIBLE TO HAVE THE "E" TYPE SAFETY LOCK WITH A PRICE INCREASE OF € 6.00.

mm	PEZZI	OLV	OBV	OCR	CRSAT	OBGR
250	2	36,00	36,00	44,00	45,00	36,50
300	2	42,00	42,00	48,00	49,00	42,50
400	2	54,00	54,00	62,00	63,00	54,50
500	2	63,00	63,00	71,00	72,00	63,50
INC A	6	4,50	4,50	6,00	6,30	4,80



**210** CATENACCIO ORIZZONTALE TONDO BASE mm. 33 CORSOIO Ø mm. 13  
 ROUND HORIZONTAL BOLT BASE mm 33 SLIDER Ø mm 13

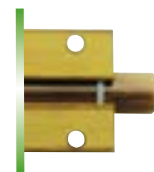

mm	PEZZI	OLV	OBV	OCR	CRSAT	ANT	OBGR	BRVYES
100	6	25,00	26,00	32,00	33,00	26,50	26,50	26,50
120	6	25,00	26,00	32,00	33,00	26,50	26,50	26,50
150	6	30,00	31,00	37,00	38,00	31,50	31,50	31,50
200	6	35,00	36,00	43,00	44,00	36,50	36,50	36,50
250	6	40,00	41,00	49,00	50,00	41,50	41,50	41,50
300	6	47,00	48,00	56,00	57,00	48,50	48,50	48,50
400	6	54,00	55,00	63,00	64,00	55,50	55,50	55,50

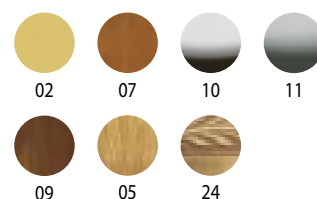

A RICHIESTA È POSSIBILE AVERE DELLE BUSSOLE IN NYLON DI PROTEZIONE CON UNA MAGGIORAZIONE DI PREZZO PARI A € 4,00 cad.  
 ON REQUEST IT IS POSSIBLE TO HAVE PROTECTION NYLON BUSHINGS WITH A PRICE INCREASE OF € 4.00.

**220** CATENACCIO VERTICALE TONDO BASE mm 33 CORSOIO Ø mm 13  
 ROUND VERTICAL BOLT BASE mm 33 SLIDER Ø mm 13

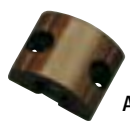
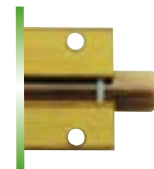
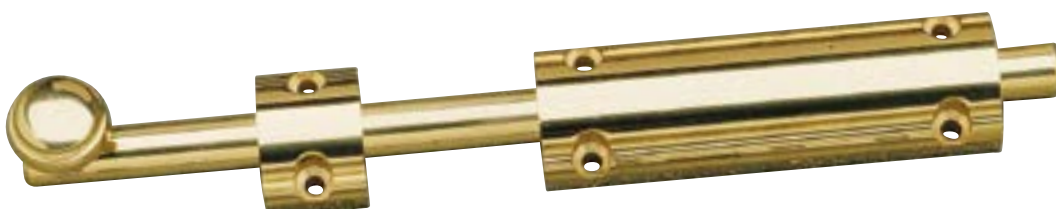

A

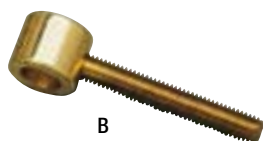

B

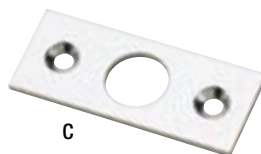

C



D

mm	PEZZI	OLV	OBV	OCR	CRSAT	ANT	OBGR	BRVYES
150	6	25,00	26,00	32,00	33,00	26,50	26,50	26,50
200	6	27,00	27,50	35,00	36,00	28,00	28,00	28,00
250	6	31,00	32,00	37,00	38,50	32,50	32,50	32,50
300	6	35,00	36,00	42,00	43,00	36,50	36,50	36,50
400	6	44,00	45,00	52,00	53,00	45,50	45,50	45,50
500	6	53,00	54,00	61,00	62,00	54,50	54,50	54,50
600	6	62,00	63,00	70,00	71,00	63,50	63,50	63,50
INC A	12	5,00	5,30	6,50	6,50	5,50	5,50	5,50
INC B	12	5,50	5,80	7,00	7,00	6,00	6,00	6,00
INC C	12	5,00	5,30	6,50	6,50	5,50	5,50	5,50
INC D	12	5,00	5,30	6,50	6,50	5,50	5,50	5,50

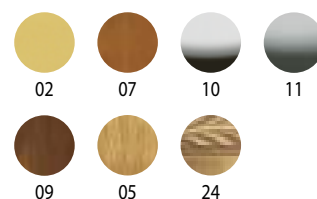

A RICHIESTA È POSSIBILE AVERE DELLE BUSSOLE IN NYLON DI PROTEZIONE CON UNA MAGGIORAZIONE DI PREZZO PARI A € 4,00 cad.  
 ON REQUEST IT IS POSSIBLE TO HAVE PROTECTION NYLON BUSHINGS WITH A PRICE INCREASE OF € 4.00.



**220 L** CATENACCIO VERTICALE TONDO BASE mm 33 CORSOIO mm 13 CON CORSA LUNGA mm 85  
 ROUND VERTICAL BOLT BASE mm 33 SLIDER Ø mm 13 WITH LONG STROKE mm 85

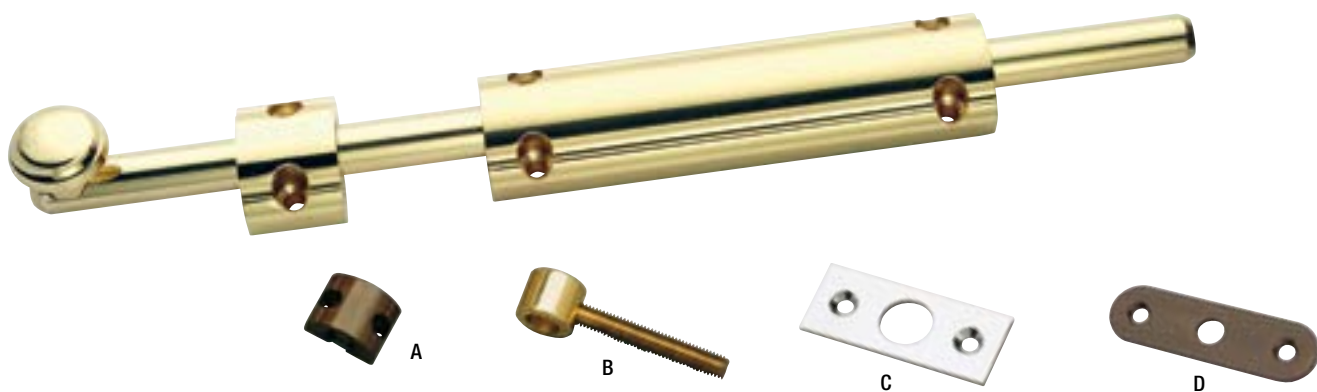

mm	PEZZI	OLV	OBV	OCR	CRSAT	ANT	OBGR	BR-YES
250	6	36,75	37,80	43,05	44,63	38,33	38,33	34,13
300	6	42,00	43,58	48,30	49,35	44,10	44,10	38,33
400	6	51,45	52,50	59,85	60,90	53,03	53,03	44,10
500	6	65,10	66,15	73,50	74,55	66,68	66,68	53,03
INC A	12	5,25	5,57	6,83	6,83	5,78	5,78	5,78
INC B	12	5,78	6,09	7,35	7,35	6,30	6,30	6,30
INC C	12	5,25	5,57	6,83	6,83	5,78	5,78	5,78
INC D	12	5,25	5,57	6,83	6,83	5,78	5,78	5,78

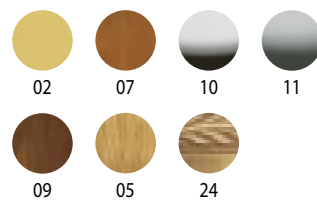

A RICHIESTA È POSSIBILE AVERE DELLE BUSSOLE IN NYLON DI PROTEZIONE CON UNA MAGGIORAZIONE DI PREZZO PARI A € 4,00 cad.  
 ON REQUEST IT IS POSSIBLE TO HAVE PROTECTION NYLON BUSHINGS WITH A PRICE INCREASE OF € 4.00.

**220 E** CATENACCIO VERTICALE TONDO BASE mm 33 CORSOIO Ø mm 13 con blocco di sicurezza  
 ROUND VERTICAL BOLT BASE mm 33 SLIDER Ø mm 13 with safety lock

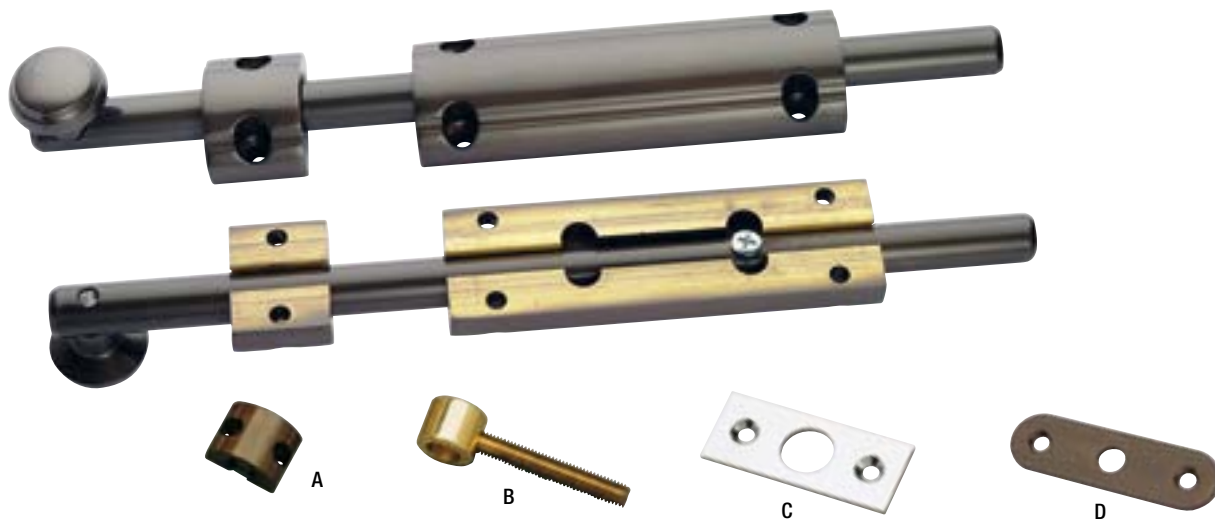

mm	PEZZI	OLV	OBV	OCR	CRSAT	ANT	OBGR	BR/YES
150	6	30,98	31,50	33,60	34,65	27,83	27,83	27,83
200	6	33,08	33,60	36,75	37,80	34,13	34,13	34,13
250	6	37,28	37,80	38,85	40,43	38,33	38,33	38,33
300	6	41,48	42,00	44,10	45,15	42,53	42,53	42,53
400	6	51,45	51,98	54,60	55,65	52,50	52,50	52,50
500	6	60,90	61,43	64,05	65,10	61,95	61,95	61,95
600	6	70,35	70,88	73,50	74,55	71,40	71,40	71,40
INC A	12	5,25	5,57	6,83	6,83	5,78	5,78	5,78
INC B	12	5,78	6,09	7,35	7,35	6,30	6,30	6,30
INC C	12	5,25	5,57	6,83	6,83	5,78	5,78	5,78
INC D	12	5,25	5,57	6,83	6,83	5,78	5,78	5,78

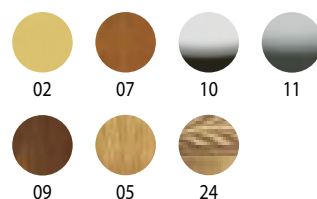

A RICHIESTA È POSSIBILE AVERE DELLE BUSSOLE IN NYLON DI PROTEZIONE CON UNA MAGGIORAZIONE DI PREZZO PARI A € 4,00 cad.  
 ON REQUEST IT IS POSSIBLE TO HAVE PROTECTION NYLON BUSHINGS WITH A PRICE INCREASE OF € 4.00.

**220 LE** CATENACCIO VERTICALE TONDO BASE mm 33 CORSOIO Ø mm 13 CON CORSA LUNGA mm 85 e blocco di sicurezza  
 ROUND VERTICAL BOLT BASE mm 33 SLIDER Ø mm 13 WITH LONG STROKE mm 85 with safety lock

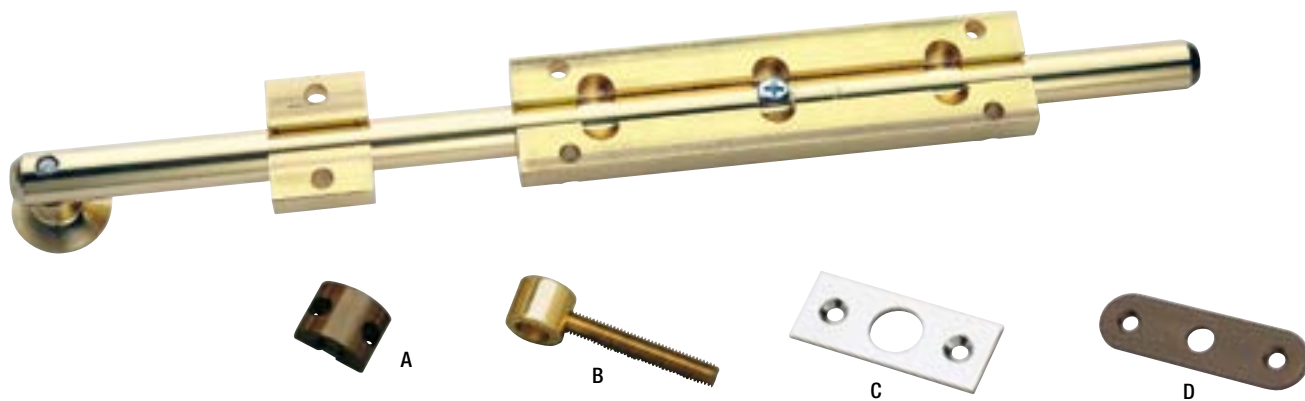

mm	PEZZI	OLV	OBV	OCR	CRSAT	ANT	OBGR	BRVYES
250	6	42,00	43,05	48,30	47,50	38,33	43,58	43,58
300	6	47,25	48,30	53,55	52,00	44,10	49,35	49,35
400	6	56,70	57,75	65,10	63,00	53,03	58,28	58,28
500	6	70,35	71,40	78,75	76,00	66,68	71,93	71,93
INC A	12	5,25	5,57	6,83	6,50	5,78	5,78	5,78
INC B	12	5,78	6,09	7,35	7,00	6,30	6,30	6,30
INC C	12	5,25	5,57	6,83	6,50	5,78	5,78	5,78
INC D	12	5,25	5,57	6,83	6,50	5,78	5,78	5,78

A RICHIESTA È POSSIBILE AVERE DELLE BUSSOLE IN NYLON DI PROTEZIONE CON UNA MAGGIORAZIONE DI PREZZO PARI A € 4,00 cad.  
 ON REQUEST IT IS POSSIBLE TO HAVE PROTECTION NYLON BUSHINGS WITH A PRICE INCREASE OF € 4.00.

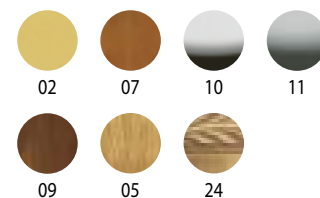

**210 S** CATENACCIO ORIZZONTALE STRETTO mm 20X19 CORSOIO Ø mm 13  
 NARROW HORIZONTAL BOLT mm 20X19 SLIDER Ø mm 13



mm	PEZZI	OLV	OBV	OCR	CRSAT	ANT	OBGR	BRVYES
100	6	27,50	28,60	35,20	36,30	29,15	29,15	29,15
120	6	27,50	28,60	35,20	36,30	29,15	29,15	29,15
150	6	33,00	34,10	40,70	41,80	34,65	34,65	34,65
200	6	38,50	39,60	47,30	48,40	40,15	40,15	40,15
250	6	44,00	45,10	53,90	55,00	45,65	45,65	45,65
300	6	51,70	52,80	61,60	62,70	53,35	53,35	53,35

A RICHIESTA È POSSIBILE AVERE DELLE BUSSOLE IN NYLON DI PROTEZIONE CON UNA MAGGIORAZIONE DI PREZZO PARI A € 4,00 cad.  
 ON REQUEST IT IS POSSIBLE TO HAVE PROTECTION NYLON BUSHINGS WITH A PRICE INCREASE OF € 4.00.

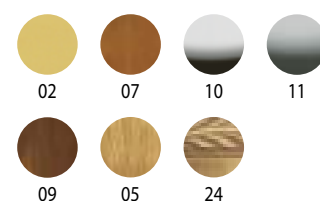

**220 S** CATENACCIO VERTICALE STRETTO mm 20X19 CORSOIO Ø mm 13  
 NARROW VERTICAL BOLT 20X19 mm SLIDER Ø 13 mm



mm	PEZZI	OLV	OBV	OCR	CRSAT	ANT	COLOR	OBGR	BRIYES
150	6	27,50	28,60	35,20	36,30	29,15	35,27	29,15	29,15
200	6	29,70	30,25	38,50	39,60	30,80	37,27	30,80	30,80
250	6	34,10	35,20	40,70	42,35	35,75	43,26	35,75	35,75
300	6	38,50	39,60	46,20	47,30	40,15	48,58	40,15	40,15
400	6	48,40	49,50	57,20	58,30	50,05	60,56	50,05	50,05
500	6	58,30	59,40	67,10	68,20	59,95	72,54	59,95	59,95
600	6	68,20	69,30	77,00	78,10	69,85	84,52	69,85	69,85
INC A	12	5,50	5,83	7,15	7,15	6,05	7,32	6,05	6,05
INC B	12	6,05	6,38	7,70	7,70	6,60	7,99	6,60	6,60

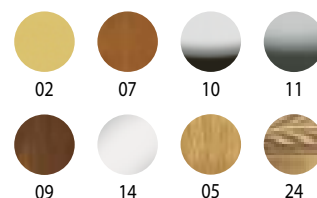

**1230** CATENACCIO ORIZZONTALE TONDO OMEGA mm 38 CORSOIO Ø mm 13  
 ROUND HORIZONTAL BOLT OMEGA mm 38 SLIDER mm Ø 13 mm

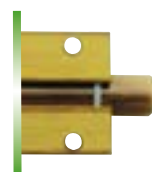
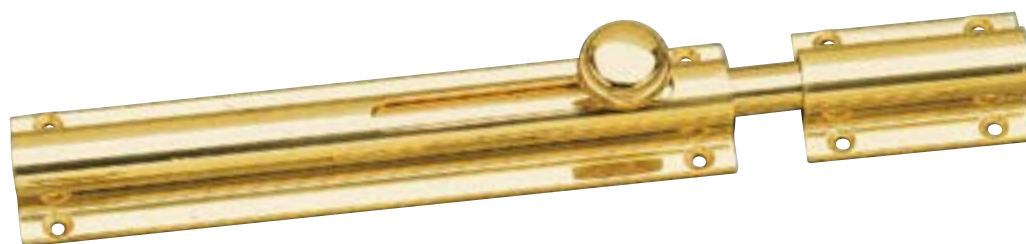

mm	PEZZI	OLV	OBV	OCR	CRSAT	ANT	OBGR	BRIYES
100	6	25,00	26,00	32,00	33,00	26,50	26,50	26,50
120	6	25,00	26,00	32,00	33,00	26,50	26,50	26,50
150	6	30,00	31,00	37,00	38,00	31,50	31,50	31,50
200	6	35,00	36,00	43,00	44,00	36,50	36,50	36,50
250	6	40,00	41,00	49,00	50,00	41,50	41,50	41,50
300	6	47,00	48,00	56,00	57,00	48,50	48,50	48,50
400	6	54,00	55,00	63,00	64,00	55,50	55,50	55,50

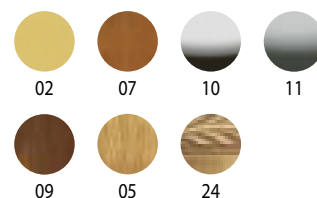

A RICHIESTA È POSSIBILE AVERE DELLE BUSSOLE IN NYLON DI PROTEZIONE CON UNA MAGGIORAZIONE DI PREZZO PARI A € 4,00 cad.  
 ON REQUEST IT IS POSSIBLE TO HAVE PROTECTION NYLON BUSHINGS WITH A PRICE INCREASE OF € 4.00 cad.

**1240** CATENACCIO VERTICALE TONDO OMEGA BASE mm 38 CORSOIO Ø mm 13  
 ROUND VERTICAL BOLT OMEGA BASE mm 38 SLIDER Ø mm 13

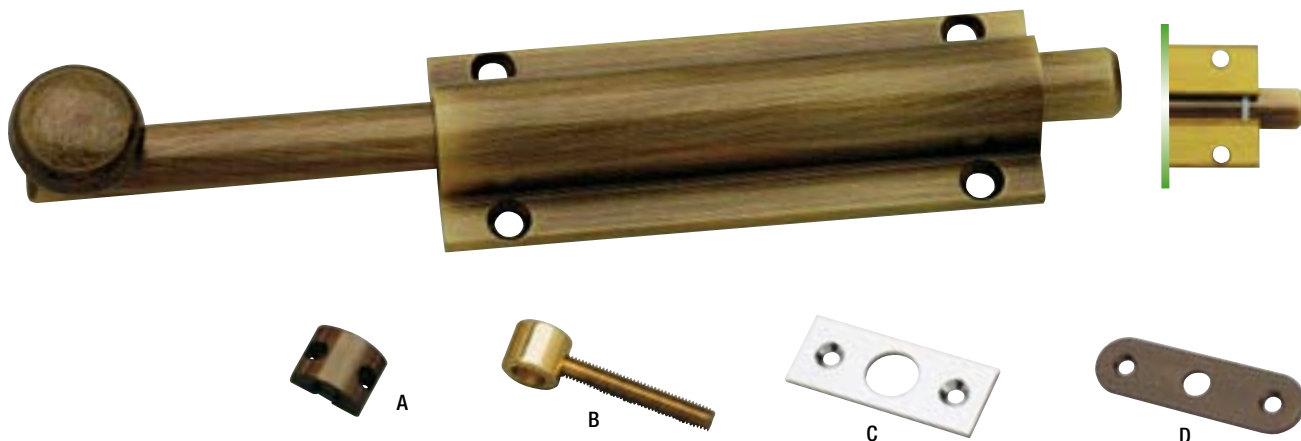

mm	PEZZI	OLV	OBV	OCR	CRSAT	ANT	OBGR	BRIVES
150	6	25,00	26,00	32,00	33,00	26,50	26,50	26,50
200	6	27,00	27,50	35,00	36,00	28,00	28,00	28,00
250	6	31,00	32,00	37,00	38,50	32,50	32,50	32,50
300	6	35,00	36,00	42,00	43,00	36,50	36,50	36,50
400	6	44,00	45,00	52,00	53,00	45,50	45,50	45,50
500	6	53,00	54,00	61,00	62,00	54,50	54,50	54,50
600	6	62,00	63,00	70,00	71,00	63,50	63,50	63,50
INC A	12	5,00	5,30	6,50	6,50	5,50	5,50	5,50
INC B	12	5,50	5,80	7,00	7,00	6,00	6,00	6,00
INC C	12	5,00	5,30	6,50	6,50	5,50	5,50	5,50
INC D	12	5,00	5,30	6,50	6,50	5,50	5,50	5,50

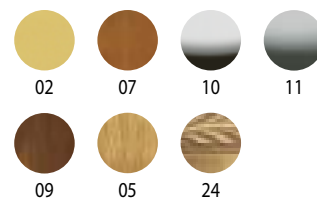

A RICHIESTA È POSSIBILE AVERE DELLE BUSSOLE IN NYLON DI PROTEZIONE CON UNA MAGGIORAZIONE DI PREZZO PARI A € 4,00 cad.  
 ON REQUEST IT IS POSSIBLE TO HAVE PROTECTION NYLON BUSHINGS WITH A PRICE INCREASE OF € 4.00.

**1230 S** CATENACCIO ORIZZONTALE TONDO OMEGA CON RIALZO PER SPAGNOLETTE CON BASE mm 38 CORSOIO Ø mm 13  
 ROUND HORIZONTAL BOLT OMEGA WITH RISE FOR ESPAGNOLETTES WITH BASE 38 mm SLIDER Ø 13 mm



mm	PEZZI	OLV	OBV	ANT	COLOR
150 S	4	45,15	45,15	47,25	45,15
200	4	53,87	53,87	55,97	53,87
300	4	71,93	71,93	71,93	71,93
400	4	85,05	85,05	87,15	85,05



• PER S SI INTENDE CATENACCI PER ANTE AD UN BATTENTE.  
 • FOR S MEANS LATCHES FOR LEAVES TO A SWING.

**1230 S SPECIAL** CATENACCIO ORIZZ. TONDO OMEGA CON RIALZO PER SPAGNOLETTE CON BASE mm 38 CORSOIO Ø mm 13 PER ANTE ALLA VICENTINA  
 ROUND HORIZONTAL BOLT OMEGA WITH RISE FOR ESPAGNOLETTES WITH BASE 38 mm SLIDER Ø 13 mm FOR DOORS "ALLA VICENTINA"



mm	PEZZI	OLV	OBV	ANT	COLOR
200	4	53,87	53,87	55,97	53,87



**220 P** POZZETTO CON MOLLA  
 FLOOR SOCKET WITH SPRING

mm Ø	PEZZI	OL
6	6	2,66
8	6	2,88
10	6	3,27
12	6	3,60
14	6	4,30
16	6	4,91
18	6	5,22
20	12	5,40
22	12	6,08



**2033** CATENACCIO A SIGARO  
 CIGAR BOLT

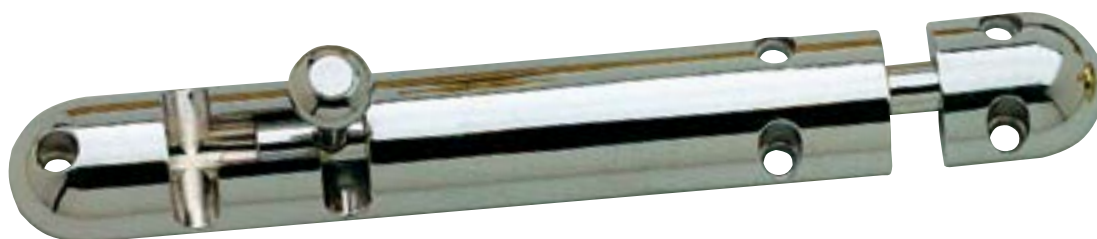

mm	PEZZI	OLV	OCR
114X22	12	12,96	14,85
150X22	12	16,20	17,55

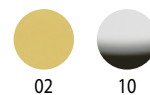

**2051** CATENACCIO FERMA PORTA ALLA VICENTINA  
*DOOR-STOP BOLT – FOR DOORS “ALLA VICENTINA”*

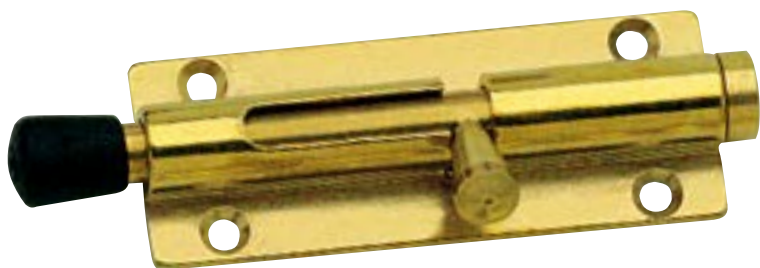

mm	PEZZI	OL	OB
80	12	6,16	6,41



**913** CATENACCIO TRADIZIONALE CON INCONTRO  
*TRADITIONAL BOLT WITH STAPLE*

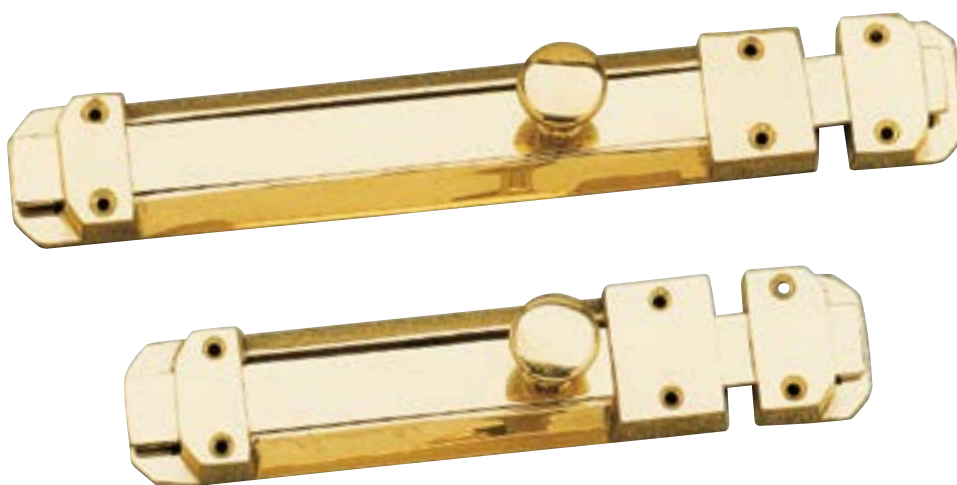

mm	PEZZI	OLV
120	6	11,88
150	6	14,04
200	6	16,20
250	6	18,90
300	6	25,47



**1** CATENACCIO ORIZZONTALE BASE mm 38 COMPLETO DI INCONTRO CORSOIO mm 15X4,5  
*HORIZONTAL BOLT BASE 38 mm COMPLETE WITH STAPLE 15X4.5 mm*

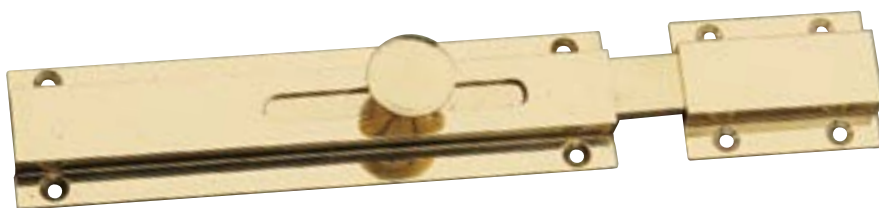

mm	PEZZI	OL	OBV	OCR
80	12	7,73	8,14	10,30
100	12	8,76	9,17	11,33
130	12	10,09	10,51	12,88
150	12	11,33	12,36	14,42
200	12	12,88	13,91	16,17
250	12	14,94	15,97	17,51
300	12	17,00	17,51	19,57



**1 B** CATENACCIO VERTICALE BASE mm 38 SENZA INCONTRO CORSOIO mm 15X4,5  
 VERTICAL BOLT BASE 38 mm WITHOUT STAPLE 15X4,5 mm

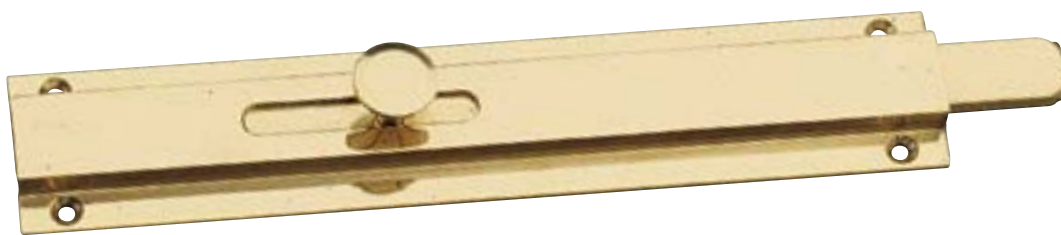

mm	PEZZI	OL	OBV	OCR
150	12	11,33	12,36	14,42
200	12	12,88	13,91	16,17
250	12	14,94	15,94	17,51
300	12	17,00	17,51	19,57
400	12	19,06	19,57	22,15
500	12	21,12	21,63	24,51
600	12	23,69	24,72	26,78
INC 15	12	1,55	1,85	2,27
INC 30	12	2,58	2,88	3,30



**1 C** CATENACCIO VERTICALE A CODA BASE mm 38 CORSOIO mm 15X4,5  
 VERTICAL LONG BOLT BASE mm 38 SLIDER mm 15X4,5

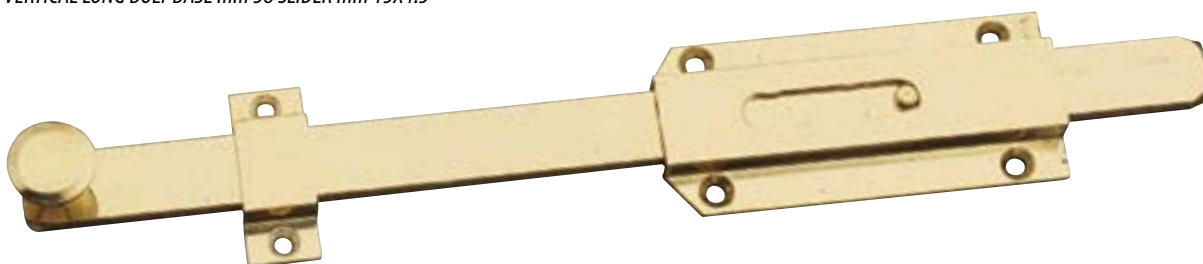

mm	PEZZI	OL	OBV	OCR
200	12	8,76	9,27	12,36
250	12	9,99	11,02	13,39
300	12	11,23	12,36	14,42
400	12	13,49	14,42	16,48
500	12	15,55	16,48	18,54
600	12	17,51	18,54	20,60



**1 D** CATENACCIO VERTICALE CON TERMINALE TONDO Ø mm10 BASE mm 38 SENZA INCONTRO CORSOIO mm 15X4,5  
 VERTICAL BOLT WITH ROUND TERMINAL Ø mm10 BASE mm 38 WITHOUT STAPLE mm 15X4,5

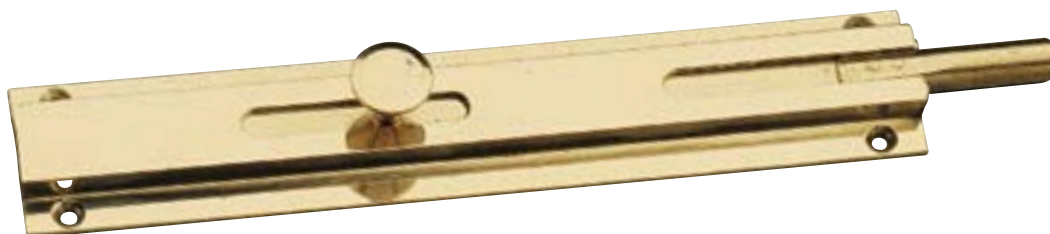

mm	PEZZI	OL	OBV	OCR
150	12	15,45	16,48	19,06
200	12	17,00	18,03	20,60
250	12	19,06	20,09	22,15
300	12	21,12	21,63	24,21
400	12	23,18	23,69	26,78
500	12	25,24	25,75	29,87
600	12	27,81	28,84	31,93



**1 G** CATENACCIO VERTICALE A GINOCCHIO BASE mm 38 CORSOIO mm 15X4,5  
 VERTICAL BOLT BASE mm 38 mm SLIDER 15X4,5



mm	PEZZI	OL	OBV	OCR
200	12	17,00	18,03	20,60
250	12	19,06	20,09	22,15
300	12	21,12	21,63	24,21
400	12	23,18	23,69	26,78
500	12	25,24	25,75	29,87
600	12	27,81	28,84	31,93



**20** CATENACCIO ORIZZONTALE PESANTE BASE mm 45 COMPLETO DI INCONTRO CORSOIO mm 20X5  
 HEAVY HORIZONTAL BOLT BASE mm 45 mm WITH STAPLE 20X5



mm	PEZZI	OL	OBV	OCR
150	6	22,05	23,10	28,35
200	6	23,10	24,15	30,45
250	6	24,15	25,20	31,50
300	6	28,35	29,40	34,65
350	6	32,55	33,60	38,85
400	6	35,70	36,75	42,00



**20 B** CATENACCIO VERTICALE PESANTE BASE mm 45 SENZA INCONTRO CORSOIO mm 20X5  
 HEAVY VERTICAL BOLT BASE mm 45 mm WITHOUT STAPLE 20X5



mm	PEZZI	OL	OBV	OCR
200	6	23,10	24,15	30,45
250	6	24,15	25,20	31,50
300	6	28,35	29,40	34,65
350	6	32,55	30,60	38,85
400	6	35,70	36,75	42,00
500	6	43,05	44,10	50,40
600	6	50,40	51,45	57,75
INC 20	6	2,10	2,21	3,15
INC 50	6	4,73	5,04	6,09

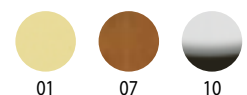



**20 C** CATENACCIO VERTICALE PESANTE BASE mm 45 SENZA INCONTRO CORSOIO mm 20X5  
 HEAVY VERTICAL BOLT BASE mm 45 WITHOUT STAPLE mm 20X5



mm	PEZZI	OL	OBV	OCR
200	6	19,57	20,60	26,78
250	6	20,60	21,63	27,81
300	6	24,72	25,75	30,90
350	6	27,81	28,84	33,99
400	6	30,90	31,93	37,08
500	6	38,11	39,14	45,32
600	6	44,29	45,32	51,50



**72** CATENACCIO VERTICALE SOTTOLAISTRA BASE mm 38 SENZA INCONTRO CORSOIO mm 15X4,5  
 VERTICAL BOLT BASE mm 38 WITHOUT STAPLE mm 15X4,5



mm	PEZZI	OL	OBV	OCR
100	12	8,76	9,17	11,33
150	12	10,09	12,36	14,42
200	12	12,88	13,91	16,17
250	12	14,94	15,97	17,51
300	12	17,00	17,51	19,57
400	12	19,06	19,57	22,15
500	12	21,12	21,63	24,51
600	12	23,69	24,72	26,78
INC 30	12	2,58	2,88	3,30



**2** CATENACCIOLO SAGOMATO BASE mm 31 CORSOIO 12X2,5 COMPLETO D'INCONTRO  
 SHAPED BOLT BASE 31 mm SLIDER 12X2,5 WITH STAPLE



mm	PEZZI	OL	OB	OCR
60	12	2,66	3,13	4,62
80	12	2,97	3,44	5,28
100	12	3,36	3,97	5,83
120	12	3,76	4,37	6,36
150	12	4,02	4,37	7,05

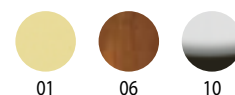

**3** CATENACCILO binario BASE mm 14  
*BINARY BOLT BASE 14 mm*



mm	PEZZI	OL	OB	OCR
60	24	1,25	1,51	2,23
70	24	1,35	1,66	2,56
80	24	1,51	1,82	2,75
90	24	1,66	1,96	2,96
100	24	1,82	2,17	3,23

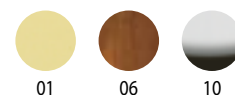

**31** CATENACCILO LEGGERO BASE mm27 SENZA INCONTRO CORSOIO mm 9X2,5  
*LIGHT BOLT BASE mm27 WITHOUT STAPLE mm 9X2,5*



mm	PEZZI	OL	OB	OCR
50	24	1,95	2,19	3,47
60	24	2,05	2,30	3,60
70	24	2,14	2,38	3,73
80	24	2,24	2,48	3,85
90	24	2,43	2,62	4,25
100	24	2,51	2,70	4,50
INC	24	0,24	0,29	0,45

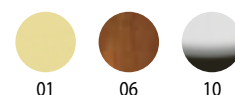

**32** CATENACCIO BINARIO GRANDE BASE mm 20 SENZA INCONTRO CORSOIO mm 15X30  
*BIG BINARY BOLT BASE 20 mm WITHOUT STAPLE 15X30 mm*



mm	PEZZI	OL	OBV
100	12	4,20	4,47
130	12	4,76	5,03
150	12	5,68	5,97
200	12	6,71	7,07
250	12	8,19	8,57
300	12	9,69	10,06
400	12	12,66	13,04
500	12	15,64	16,12
600	12	18,61	19,09
INC 30	12	0,74	0,90

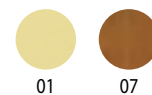

**135** CATENACCIO AMERICA  
BOLT AMERICA



mm	PEZZI	OL
600	1	44,69
450	1	42,54
400	1	39,81
350	1	34,49
300	1	32,31
200	6	27,31
150	6	24,73
120	6	18,55
100	6	17,84
80	6	17,69
INC A	6	1,30
INC B	6	1,30
INC C	6	3,81

01

**136** CATENACCIO SFACCETTATO CON INCONTRO  
MULTIFACETED BOLT WITH STAPLE

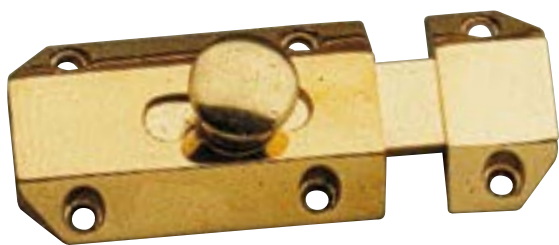

mm	PEZZI	OL
50	1	7,42
75	1	10,55
100	1	14,85
120	1	18,23
150	1	22,24
200	6	30,98

01

**33** CATENACCIO TONDO CON MOLLA BASE mm 31 SENZA INCONTRO CORSOIO Ø mm 8,5  
 ROUND BOLT WITH SPRING BASE mm 31 WITHOUT STAPLE Ø mm 8,5

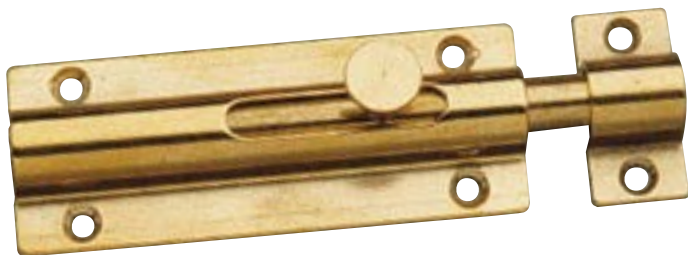

mm	PEZZI	OL	OLV	OBV	OCR
60	12	3,04		3,38	5,25
80	12	3,56		3,95	5,97
100	12	4,08		4,46	6,63
120	12	4,59		5,10	7,46
150	12	5,35	7,05	5,78	8,46
200	12	6,79	8,50	7,33	10,45
250	12	8,15	9,84	8,70	12,20
300	12	9,52	11,21	10,06	14,15
400	12	12,23	13,92	12,77	17,69
500	12	14,79	16,63	15,48	21,22
600	12	17,82	19,53	18,68	25,42
INC	12	0,58	0,73	0,62	0,95

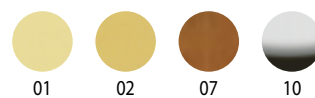

**33 C** TONDO A GINOCCHIO CON MOLLA BASE mm 31 CORSOIO Ø mm 8,5  
 ROUND BOLT WITH SPRING BASE mm 31 SLIDER Ø mm 8,5

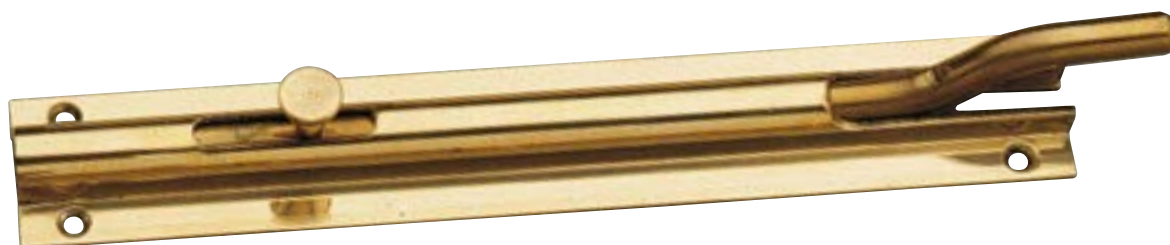

mm	PEZZI	OL	OBV
150	12	8,40	8,99
200	12	9,58	10,16
250	12	11,04	11,62
300	12	12,66	13,25
400	12	15,60	16,19
500	12	18,54	19,15

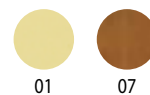

**90** CATENACCIO A CANNONE BASE mm 31 SENZA INCONTRO CORSOIO Ø mm 8,5  
 CANNON BOLT BASE mm 31 WITHOUT STAPLE Ø mm 8,5



mm	PEZZI	OL	OLV	OBV	OCR
60	12	3,37	-	9,83	5,75
80	12	3,93	-	11,15	6,51
100	12	4,46	-	14,29	7,19
120	12	5,09	-	17,38	8,17
150	12	5,89	-	22,28	9,23
200	12	7,58	9,66	0,72	12,18
250	12	9,18	10,97	9,14	13,35
300	12	10,69	12,48	10,56	15,68
400	12	13,82	15,59	13,41	20,31
500	12	16,95	18,72	16,25	24,36
600	12	21,39	23,17	19,61	31,33
INC	12	0,65	0,87	0,65	1,09

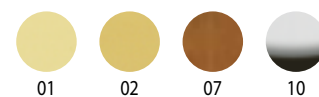

**229** CATENACCIO A CRIMAGLERA  
 RACK BOLT



mm	PEZZI	OLV	CRSAT	OBGR
60	6	18,25	22,75	20,25
80	6	18,25	22,75	20,25
100	6	19,50	23,75	21,50





**CERNIERE**  
*hinges*

**861** CERNIERA A LIBRO SFILABILE CON CUSCINETTO E PERNO IN ACCIAIO INOX DX-SX  
 REMOVABLE BOOK HINGE WITH BALL BEARING AND PIN IN STAINLESS STEEL RIGHT-LEFT

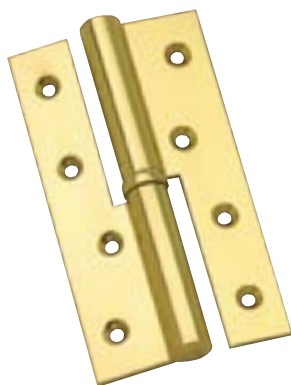

mm	PEZZI	OLV	OBV ANT OBGR BR-YESTER OROVAL	OCR	CRSAT	NIKISAT FERVANT
100	2	25,30	26,45	31,05	32,20	32,78
120	2	28,75	29,90	34,50	35,65	36,23
140	2	32,20	33,35	38,53	39,68	40,25
160	2	39,10	40,25	46,00	47,15	47,73

NELLA MISURA DI mm 120 È POSSIBILE AVERE LA REGOLAZIONE VERTICALE  
 CON EXTRA € 4,40 CAD.  
 IN THE MEASURE OF 120 mm IT IS POSSIBLE TO HAVE THE VERTICAL ADJUSTMENT  
 WITH EXTRA € 4,40/pc.

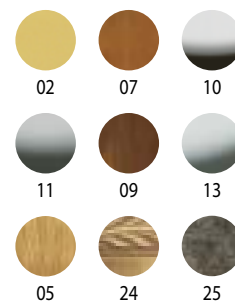

**861 P** CERNIERA A LIBRO SFILABILE CON CUSCINETTO E PERNO IN ACCIAIO INOX DX-SX CON PIRAMIDE  
 REMOVABLE BOOK HINGE WITH BALL BEARING AND PIN IN STAINLESS STEEL RIGHT-LEFT WITH PYRAMID



mm	PEZZI	OLV	OBV ANT OBGR BR-YESTER OROVAL	OCR	CRSAT	NIKISAT FERVANT
100	2	30,80	31,90	36,30	37,40	37,95
120	2	34,10	35,20	39,60	40,70	41,25
140	2	37,40	38,50	43,45	44,55	45,10
160	2	44,00	45,10	50,60	51,70	52,25

NELLA MISURA DI mm 120 È POSSIBILE AVERE LA REGOLAZIONE VERTICALE  
 CON EXTRA € 4,40 CAD.  
 IN THE MEASURE OF 120 mm IT IS POSSIBLE TO HAVE THE VERTICAL ADJUSTMENT  
 WITH EXTRA € 4,40/pc.

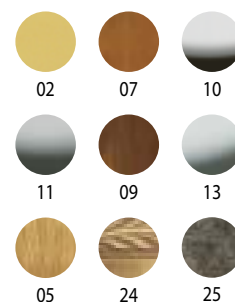

**861 GP** CERNIERA A LIBRO GIGANTE SFILABILE CON CUSCINETTO E PERNO IN ACCIAIO INOX DX-SX SPESSORE mm 5 CON PIRAMIDE  
 BIG REMOVABLE BOOK HINGE WITH BALL BEARING AND PIN IN STAINLESS STEEL RIGHT-LEFT THICKNESS 5 mm WITH PYRAMID



mm	PEZZI	OLV	OBV ANT OBGR BR-YESTER OROVAL	OCR	CRSAT	NIKISAT FERVANT
140	2	45,60	45,60	52,20	53,40	54,00
160	2	54,00	54,00	61,20	62,40	63,00

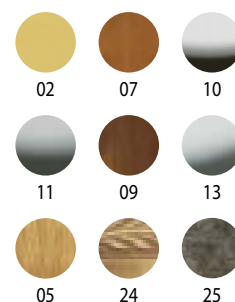

**861 G PRG** CERNIERA A LIBRO SFILABILE CON CUSCINETTO E PERNO IN ACCIAIO INOX DX-SX RIGATA SPESSORE mm 5 CON PIRAMIDE  
 BIG STRIPED REMOVABLE BOOK HINGE MODEL "GHIANDA" WITH BALL BEARING AND PIN IN STAINLESS STEEL RIGHT-LEFT THICKNESS 5 mm WITH PYRAMID



mm	PEZZI	OLV	OBV ANT OBGR BR-YESTER OROVAL	OCR	CRSAT	NIKISAT FERVANT
140	2	45,60	45,60	52,20	53,40	54,00
160	2	54,00	54,00	61,20	62,40	63,00

NELLA MISURA DI mm 120 È POSSIBILE AVERE LA REGOLAZIONE VERTICALE  
 CON EXTRA € 4,40 CAD.  
 IN THE MEASURE OF 120 mm IT IS POSSIBLE TO HAVE THE VERTICAL ADJUSTMENT  
 WITH EXTRA € 4,40/pc.

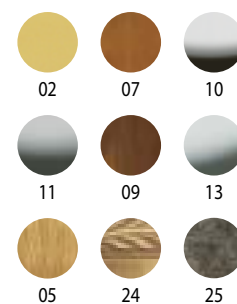

**861 PR** CERNIERA A LIBRO SFILABILE CON CUSCINETTO E PERNO IN ACCIAIO INOX DX-SX RIGATA CON PIRAMIDE  
 STRIPED REMOVABLE BOOK HINGE WITH BALL BEARING AND PIN IN STAINLESS STEEL RIGHT-LEFT WITH PYRAMID

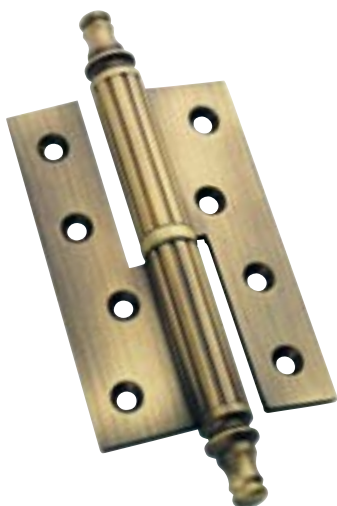

mm	PEZZI	OLV	OBV ANT OBGR BR-YESTER OROVAL	OCR	CRSAT	NIKISAT FERVANT
120	2	37,40	39,50	45,10	45,10	45,65

NELLA MISURA DI mm 120 È POSSIBILE AVERE LA REGOLAZIONE VERTICALE  
 CON EXTRA € 4,40 CAD.  
 IN THE MEASURE OF 120 mm IT IS POSSIBLE TO HAVE THE VERTICAL ADJUSTMENT  
 WITH EXTRA € 4,40/pc.

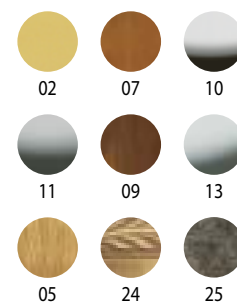

**861 PRG** CERNIERA A LIBRO MOD.QUERCIA SFILABILE CON CUSCINETTO E PERNO IN ACCIAIO INOX DX-SX RIGATA CON PIRAMIDE  
 STRIPED REMOVABLE BOOK HINGE MODEL "QUERCIA" WITH BALL BEARING AND PIN IN STAINLESS STEEL RIGHT-LEFT WITH PYRAMID

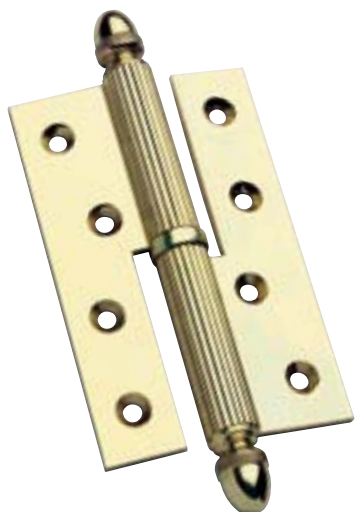

mm	PEZZI	OLV	OBV ANT OBGR BR-YESTER OROVAL	OCR	CRSAT	NIKISAT FERVANT
120	2	37,40	39,05	45,10	45,10	45,65

NELLA MISURA DI mm 120 È POSSIBILE AVERE LA REGOLAZIONE VERTICALE  
 CON EXTRA € 4,40 CAD.  
 IN THE MEASURE OF 120 mm IT IS POSSIBLE TO HAVE THE VERTICAL ADJUSTMENT  
 WITH EXTRA € 4,40/pc.

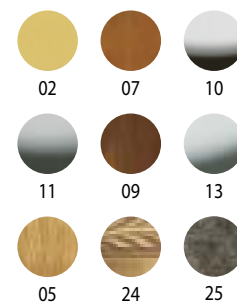



**862** CERNIERA A LIBRO ZANCATA SFILABILE CON CUSCINETTO E PERNO IN ACCIAIO INOX DX-SX  
 REMOVABLE CLAMP BOOK HINGE WITH BALL BEARING AND PIN IN STAINLESS STEEL RIGHT-LEFT



mm	PEZZI	OLV	OBV ANT OBGR BR-YESTER OROVAL	OCR	CRSAT	NIKISAT FERVANT
100	2	28,18	28,18	33,93	35,08	36,23
120	2	31,05	31,05	36,80	37,95	38,53
140	2	34,50	34,50	40,25	41,40	41,98
160	2	39,10	39,10	44,85	46,00	51,18

NELLA MISURA DI mm 120 È POSSIBILE AVERE LA REGOLAZIONE VERTICALE  
 CON EXTRA € 4,40 CAD.  
 IN THE MEASURE OF 120 mm IT IS POSSIBLE TO HAVE THE VERTICAL ADJUSTMENT  
 WITH EXTRA € 4,40/pc.

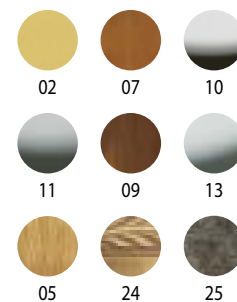

**862 P** CERNIERA A LIBRO ZANCATA SFILABILE CON CUSCINETTO E PERNO IN ACCIAIO INOX DX-SX CON PIRAMIDE  
 REMOVABLE CLAMP BOOK HINGE BALL BEARING AND PIN IN STAINLESS STEEL RIGHT-LEFT WITH PYRAMID



mm	PEZZI	OLV	OBV ANT OBGR BR-YESTER OROVAL	OCR	CRSAT	NIKISAT FERVANT
100	2	33,55	38,12	39,05	40,15	41,25
120	2	36,30	41,14	41,80	42,90	44,00
140	2	39,60	44,77	45,10	46,20	47,30
160	2	44,00	45,10	49,50	50,60	51,70

NELLA MISURA DI mm 120 È POSSIBILE AVERE LA REGOLAZIONE VERTICALE  
 CON EXTRA € 4,40 CAD.  
 IN THE MEASURE OF 120 mm IT IS POSSIBLE TO HAVE THE VERTICAL ADJUSTMENT  
 WITH EXTRA € 4,40/pc.

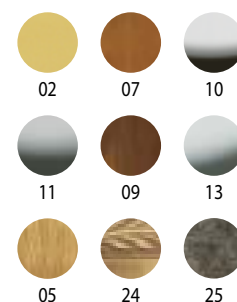

**862 PRG** CERNIERA A LIBRO MOD.QUERCIA ZANCATA SFILABILE CON CUSCINETTO E PERNO IN ACCIAIO INOX DX-SX RIGATA CON PIRAMIDE  
 STRIPED REMOVABLE CLAMP BOOK HINGE MODEL "QUERCIA" WITH BALL BEARING AND PIN IN STAINLESS STEEL RIGHT-LEFT WITH PYRAMID



mm	PEZZI	OLV	OBV ANT OBGR BR-YESTER OROVAL	OCR	CRSAT	NIKISAT FERVANT
120	2	41,40	43,13	49,45	50,60	51,18

NELLA MISURA DI mm 120 È POSSIBILE AVERE LA REGOLAZIONE VERTICALE  
 CON EXTRA € 4,40 CAD.  
 IN THE MEASURE OF 120 mm IT IS POSSIBLE TO HAVE THE VERTICAL ADJUSTMENT  
 WITH EXTRA € 4,40/pc.

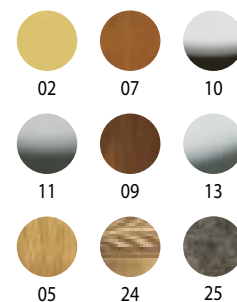

**79** CERNIERA SFILABILE REGOLABILE E REVERSIBILE CON PREMONTAGGIO  
 ADJUSTABLE REVERSIBLE REMOVABLE HINGE WITH PRE-ASSEMBLY

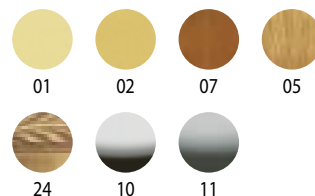

mm	PEZZI	OL	OLV	OBV OBGR BR-YESTER	OCR	CRSAT
	2	14,28	20,16	20,16	26,60	26,60

**79 P** CERNIERA SFILABILE REGOLABILE E REVERSIBILE CON PIRAMIDE E PREMONTAGGIO  
 ADJUSTABLE REVERSIBLE REMOVABLE HINGE WITH PYRAMID AND PRE-ASSEMBLY

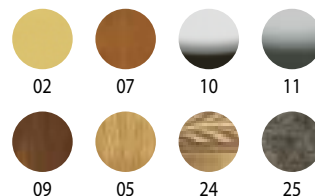

mm	PEZZI	OLV	OBV BR-ANT OBGR BR-YESTER	OCR	CRSAT	FERVANT
	2	20,16	22,96	28,56	28,56	28,56

**79 PRG** CERNIERA SFILABILE REGOLABILE E REVERSIBILE RIGATA CON PIRAMIDE E PREMONTAGGIO  
 STRIPED ADJUSTABLE REVERSIBLE REMOVABLE HINGE WITH PYRAMID AND PRE-ASSEMBLY

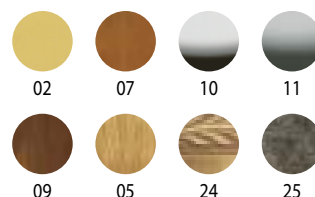

mm	PEZZI	OLV	OBV BR-ANT OBGR BR-YESTER	OCR	CRSAT	FERVANT
	2	23,80	24,36	29,96	29,96	29,96

**R 861** CERNIERA A LIBRO SFILABILE CON CUSCINETTO E PERNO IN ACCIAIO INOX DX-SX REGOLABILI CON PREMONTAGGIO  
 ADJUSTABLE REMOVABLE BOOK HINGE WITH BALL BEARING AND PIN IN STAINLESS STEEL RIGHT-LEFT WITH PRE-ASSEMBLY

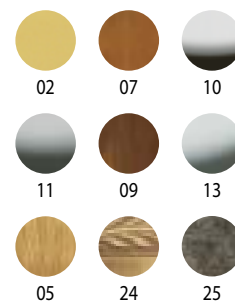
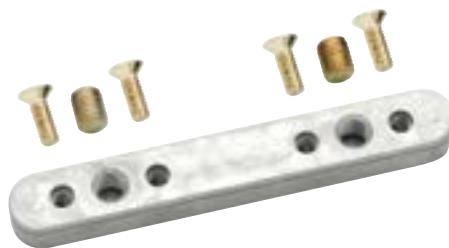

mm	PEZZI	OLV	OBV BR-ANT OBGR BR-YESTER	OCR	CRSAT	NIK'SAT FERVANT
	2	35,00	35,50	41,00	42,00	42,50

**R 861 P** CERNIERA A LIBRO SFILABILE CON CUSCINETTO E PERNO IN ACCIAIO INOX DX-SX CON PIRAMIDE REGOLABILE CON PREMONTAGGIO  
 ADJUSTABLE REMOVABLE BOOK HINGE WITH BALL BEARING AND PIN IN STAINLESS STEEL RIGHT-LEFT WITH PYRAMID AND PRE-ASSEMBLY

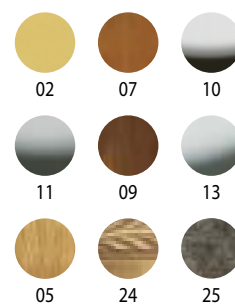

mm	PEZZI	OLV	OBV BR-ANT OBGR BR-YESTER	OCR	CRSAT	NIK'SAT FERVANT
	2	41,00	42,00	46,00	47,00	47,50

**R 861 PRG** CERNIERA A LIBRO SFILABILE MOD. QUERCIA CON CUSCINETTO E PERNO IN ACCIAIO INOX DX-SX RIGATA CON PIRAMIDE  
 REGOLABILE CON PREMONTAGGIO  
 ADJUSTABLE REMOVABLE BOOK HINGE MODEL "QUERCIA" WITH BALL BEARING AND PIN IN STAINLESS STEEL RIGHT-LEFT WITH PYRAMID AND PRE-ASSEMBLY

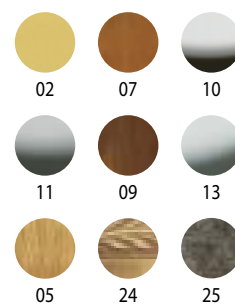
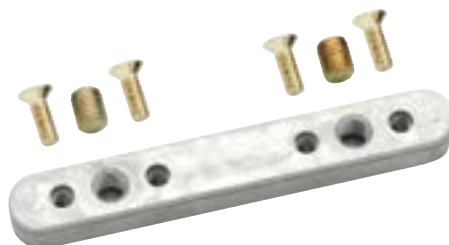

mm	PEZZI	OLV	OBV BR-ANT OBGR BR-YESTER	OCR	CRSAT	NIK'SAT FERVANT
	2	42,00	43,00	50,00	51,00	51,50

**R 862** CERNIERA A LIBRO ZANCATA SFILABILE CON CUSCINETTO E PERNO IN ACCIAIO INOX DX-SX REGOLABILE CON PREMONTAGGIO  
 ADJUSTABLE CLAMP BOOK HINGE WITH BALL BEARING AND PIN IN STAINLESS STEEL RIGHT-LEFT WITH PRE-ASSEMBLY

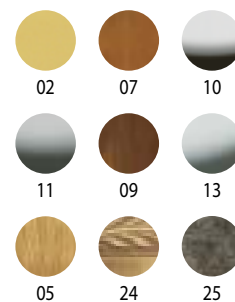
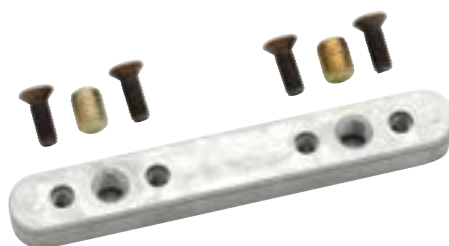

mm	PEZZI	OLV	OBV BR-ANT OBGR BR-YESTER	OCR	CRSAT	NIK\SAT FERVANT
	2	37,00	38,00	42,00	43,00	43,50

**R 862 P** CERNIERA A LIBRO ZANCATA SFILABILE CON CUSCINETTO E PERNO IN ACCIAIO INOX DX-SX CON PIRAMIDE REGOLABILE CON PREMONTAGGIO  
 ADJUSTABLE CLAMP BOOK HINGE WITH BALL BEARING AND PIN IN STAINLESS STEEL DX-SX. WITH PYRAMID AND PRE-ASSEMBLY

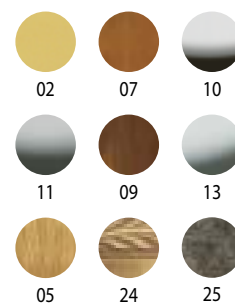
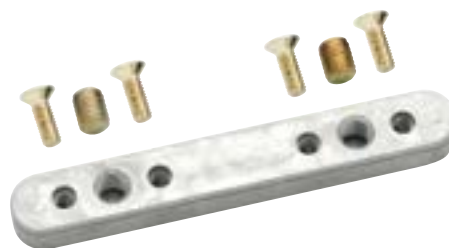

mm	PEZZI	OLV	OBV BR-ANT OBGR BR-YESTER	OCR	CRSAT	NIK\SAT FERVANT
	2	43,00	44,00	48,00	49,00	49,50

**R 862 PRG** CERNIERA A LIBRO MOD. QUERCIA ZANCATA SFILABILE CON CUSCINETTO E PERNO IN ACCIAIO INOX DX-SX RIGATA CON PIRAMIDE REGOLABILE CON PREMONTAGGIO  
 ADJUSTABLE CLAMP BOOK HINGE MODEL "QUERCIA" WITH BALL BEARING AND PIN IN STAINLESS STEEL DX-SX WITH PYRAMID AND PRE-ASSEMBLY

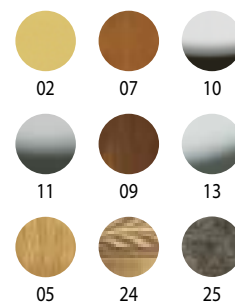
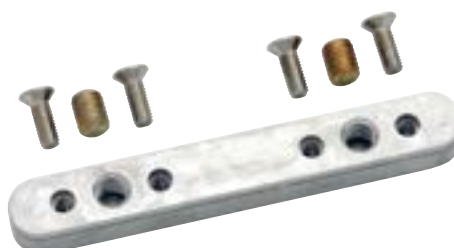

mm	PEZZI	OLV	OBV BR-ANT OBGR BR-YESTER	OCR	CRSAT	NIK\SAT FERVANT
	2	45,00	46,00	50,00	51,00	51,50

# CERNIERE REGOLABILI

La nostra ditta dopo uno studio dettagliato delle problematiche di regolazione delle porte ha deciso di proporre nuove soluzioni.

Siamo lieti di presentarvi due nuove linee di produzione:

- 1 - L'articolo 79 - 79P - 79PRG cerniere regolabili in verticale e orizzontale e reversibili, con un solo tipo di cerniera si può montare una porta sia con l'apertura destra che a sinistra.  
La regolazione verticale è di 5 mm e alza la porta evitando il contatto con il pavimento.  
La regolazione orizzontale è da 1 a 5 mm permette di mettere in asse la porta in parallelo al pavimento.  
Per questa regolazione la cerniera è fornita con un pre-montaggio che si monta nello stipite dove precedentemente viene fatta un'asola di un ingombro di mm 49x20 con una profondità di mm 12.  
La porta può essere smontata in qualsiasi momento senza intervenire sulle viti di fissaggio.

Portata cerniere:

Art. 79 - Kg. 28

- 2 - L'articolo 861 - 861P - 861PRG - 862 - 862P - 862PRG sono cerniere simili a quelle in produzione ma regolabili in verticale e in orizzontale.  
Sono prodotte solamente nelle misure da 120 mm.  
La regolazione verticale è di 5 mm e alza la porta evitando il contatto con il pavimento.  
La regolazione orizzontale è da 1 a 5 mm permette di mettere in asse la porta in parallelo al pavimento.  
Per questa regolazione la cerniera è fornita con un pre-montaggio che si monta nello stipite dove precedentemente viene fatta un'asola di un ingombro di mm 108x15 con una profondità di mm 12.  
La porta può essere smontata in qualsiasi momento senza intervenire sulle viti di fissaggio.

Portata cerniere:

Art. 861 - 862 - Kg. 30

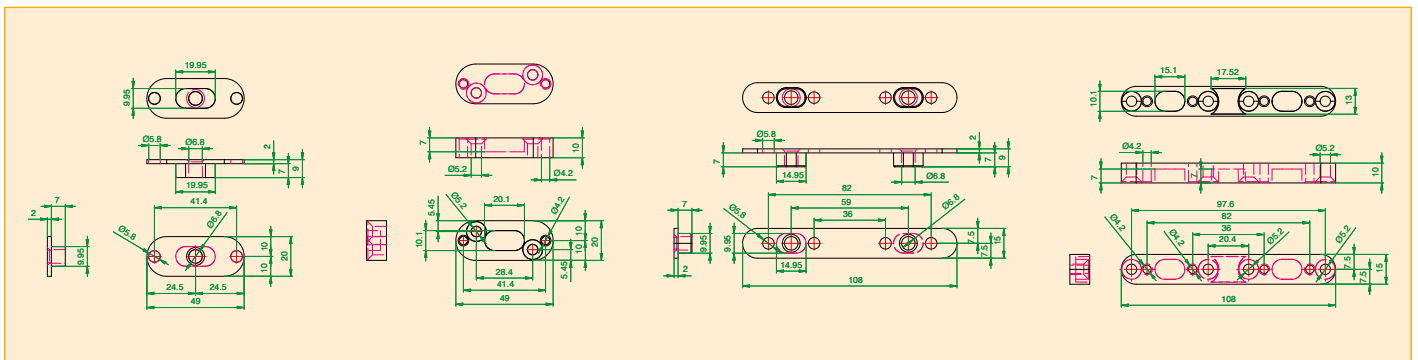

# ADJUSTABLE HINGES

Our company after a carefully studying the problems of door adjustments has decided to propose new solutions.  
We are pleased to introduce two new products lines

- 1 - Article 79 - 79P - 79PRG adjustable hinges vertical and horizontal and reversible.  
With only one type of hinge you can mount a door opening both right and left hand.  
The vertical adjustment is 5 mm and it raises the door avoiding contact with the floor.  
The horizontal adjustment is 4/5 mm, and allows to put the door in axis and parallel to the floor.  
For this adjustment, the hinge is provided with a pre-assembled system that is mounted on the door frame where was previously made a hole of 49x20 mm with a depth of 12 mm.  
The door can be disassembled at any time without affecting the mounting screws.

Load capacity hinge:

Art. 79 - Kg. 28

- 2 - Article 861 - 861PRG - 861P - 862P - 862P - 862PRG hinges are similar to those in production, but adjustable vertically and horizontally.  
They are manufactured only in the 120 mm measure.  
The vertical adjustment is 5 mm and it raises the door avoiding contact with the floor.  
The horizontal adjustment is 4/5 mm. It allows to put the door in axis and parallel to the floor.  
For this adjustment, the hinge is provided with a pre-assembled system that is mounted in the door frame where was previously made a hole of 108x15 mm with a depth of 12 mm.  
The door can be disassembled at any time without affecting the mounting screws.

Load capacity hinge:

Art. 861 - 862 - Kg. 30

## REGOLAZIONE CERNIERE

### REGOLAZIONE VERTICALE

Svitare il terminale in alto utilizzando una chiave esagonale da 5 mm per gli articoli 79 - 79P - 79PRG e da 6 mm per gli articoli 861 - 861P - 861 PRG e avvitare la brugola per alzare la porta.

### REGOLAZIONE ORIZZONTALE

Per gli articoli 79 - 79P - 79PRG allentare le viti con un cacciavite, per mettere in asse la porta, regolare con una chiave esagonale da 4 mm la brugola centrale dal foro centrale sull'aletta della cerniera, finita la regolazione bisogna bloccare le viti al pre-montaggio.

Per gli articoli 861 - 861P - 861PRG - 862 - 862P - 862PRG in fase di montaggio, fissare le viti centrali, allentare le viti con un cacciavite, per mettere in asse la porta, regolare con una chiave esagonale da 4 mm le due brugole centrali ai fori sull'aletta della cerniera, finita la regolazione bisogna bloccare le viti al pre-montaggio.

## HINGES ADJUSTING

### VERTICAL ADJUSTMENT

*Unscrew the terminal at the top of the hinge with a 5 m hexagonal key for items 79 - 79 P - 79 PRG and 6 mm for items 861 - 861 P - 861 PRG - 862 - 862 P - 862 PRG and screw the grub screw to raise the door.*

### HORIZONTAL ADJUSTMENT

*For items 79 - 79 P - 79 PRG loose the screws with a screwdriver, to put the door in axis. Adjust with a 4 mm hexagonal key the central grub screw from the center hole on the hinge wing. After the adjustment lock the screws on the pre-assembled system.*

*For items 861 - 861 P - 861 PRG - 862 - 862 P - 862 PRG during the assembling, fix the centrals screws, loose the screws with a screwdriver to put the door in axis, adjust with a 4 mm hexagonal key the two grub screws to the central holes on the hinge wing. After the adjustment lock all the screws on the pre-assembled system.*

**85 CERNIERA CON TERMINALI COMPLETA DI VITI CON CANOTTO Ø mm 10,5**  
**HINGE WITH TERMINALS WITH SLEEVE Ø 10.5 mm**

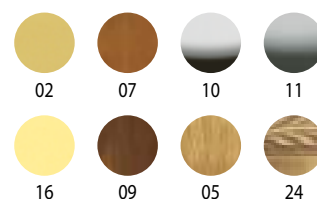
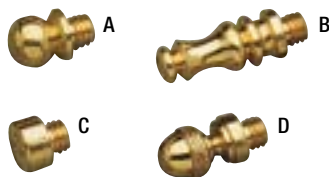
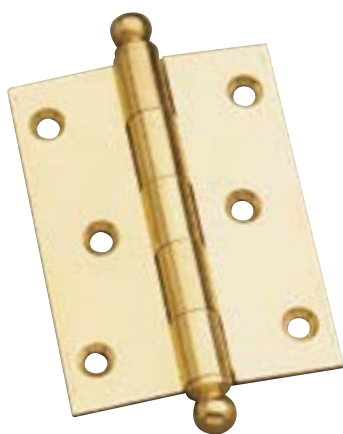

mm	PEZZI	OLV	OBV ANT OBGR BR-YESTER OROVAL	OCR	CRSAT	NIK'SAT FERVANT	ORO
63X52	12	7,19	7,72	10,71	11,76	12,29	13,34
63X63	12	7,19	7,72	10,71	11,76	12,29	13,34
76X52	12	8,09	8,61	11,55	12,60	14,49	15,54
76X63	12	8,09	8,61	11,55	12,60	14,49	15,54

• LA SCELTA DEI TERMINALI DEI TERMINALI A-B-C-D ANDRÀ SPECIFICATA AL MOMENTO DELL'ORDINE.  
 THE TYPE OF TERMINAL (A, B, C or D) MUST BE INDICATED IN THE INQUIRY.

\*\* EXTRA PREZZO PER BORDO TONDO 0,40 CAD. - EXTRA PRICE FOR ROUND EDGE € 0.40/pc.

**85 CERNIERA CON TERMINALI COMPLETA DI VITI CON CANOTTO Ø mm 12,5**  
**HINGE WITH TERMINALS COMPLETE WITH SCREWS WITH SLEEVE Ø 12.5 mm**

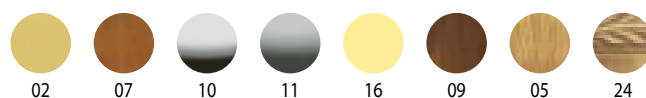

mm	PEZZI	OLV	OBV ANT OBGR BR-YESTER OROVAL	OCR	CRSAT	NIK'SAT FERVANT	ORO
76X76	4	13,00	13,50	16,50	17,50	18,50	19,50
89X76	4	15,80	16,30	19,80	20,80	21,80	22,80
89X89	4	16,80	17,30	20,80	21,80	22,80	23,80
102X76	4	17,60	18,10	21,60	22,60	23,60	24,80
102X89	4	19,00	19,50	23,00	24,00	25,00	26,40
102X102	3	21,00	21,50	25,00	26,00	27,00	28,40
115X102	3	23,50	24,00	27,50	28,50	29,50	31,00
115X115	3	24,50	25,00	28,50	29,50	30,50	32,00
126X89	3	26,50	27,00	30,50	31,50	32,50	35,50
126X102	3	27,50	27,50	31,50	32,50	33,50	35,50

• LA SCELTA DEI TERMINALI DEI TERMINALI A-B-C-D ANDRÀ SPECIFICATA AL MOMENTO DELL'ORDINE.  
 THE TYPE OF TERMINAL (A, B, C or D) MUST BE INDICATED IN THE INQUIRY.

\*\* EXTRA PREZZO PER BORDO TONDO 0,40 CAD. - EXTRA PRICE FOR ROUND EDGE € 0.40/pc.

**86 CERNIERA CON TERMINALI E CUSCINETTI COMPLETA DI VITI CON CANOTTO Ø mm 10,5**  
**HINGE WITH TERMINALS AND BALL BEARINGS WITH SLEEVE Ø 10.5 mm**

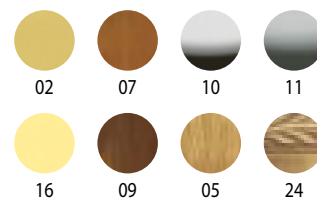
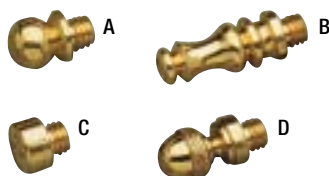

mm	PEZZI	OLV	OBV ANT OBGR BR-YESTER OROVAL	OCR	CRSAT	NIK'SAT FERVANT	ORO
63X52	12	7,85	8,35	11,20	12,20	12,70	13,70
63X63	12	7,85	8,35	11,20	12,20	12,70	13,70
76X52	12	8,70	9,20	12,00	13,00	15,30	16,30
76X63	12	8,70	9,20	12,00	13,00	15,30	16,30

• LA SCELTA DEI TERMINALI DEI TERMINALI A-B-C-D ANDRÀ SPECIFICATA AL MOMENTO DELL'ORDINE.  
 THE TYPE OF TERMINAL (A, B, C or D) MUST BE INDICATED IN THE INQUIRY.

\*\* EXTRA PREZZO PER BORDO TONDO 0,40 CAD. - EXTRA PRICE FOR ROUND EDGE € 0.40/pc.

**86** CERNIERA CON TERMINALI E CUSCINETTI COMPLETA DI VITI CON CANOTTO Ø mm 12,5  
 HINGE WITH TERMINALS AND BALL BEARINGS WITH SCREWS WITH SLEEVE Ø 12.5 mm

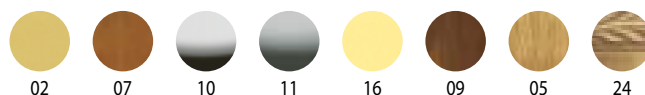
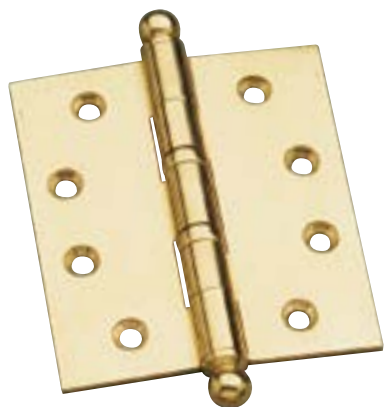

mm	PEZZI	OLV	OBV ANT OBGR BR-YESTER ORO\VAL	OCR	CRSAT	NIK\SAT FERVANT	ORO
76X76	4	14,00	14,50	17,50	18,50	19,00	20,00
89X76	4	16,80	17,30	20,80	20,80	21,30	23,80
89X89	4	17,80	18,30	21,80	22,80	23,30	24,80
102X76	4	18,60	19,10	22,60	23,60	24,10	25,80
102X89	4	20,00	20,50	24,00	25,00	25,50	27,40
102X102	3	22,00	20,50	26,00	27,00	27,50	29,40
115X102	3	24,50	25,00	28,50	29,50	30,00	32,00
115X115	3	25,50	26,00	29,50	30,50	31,00	33,00
126X89	3	27,50	28,00	31,50	32,50	33,00	35,50
126X102	3	28,50	29,00	32,50	33,50	34,00	36,50
152X89	3	36,00	36,50	41,50	42,50	43,00	45,50
152X102	3	37,00	37,50	42,50	43,50	44,00	46,50
152X115	3	39,00	39,50	44,50	45,50	46,00	48,50



• LA SCELTA DEI TERMINALI DEI TERMINALI A-B-C-D ANDRÀ SPECIFICATA AL MOMENTO DELL'ORDINE.  
 THE TYPE OF TERMINAL (A, B, C or D) MUST BE INDICATED IN THE INQUIRY.

\*\* EXTRA PREZZO PER BORDO TONDO 0,40 CAD. - EXTRA PRICE FOR ROUND EDGE € 0.40/pc.

**86 G** CERNIERA CON TERMINALI E CUSCINETTI CON CANOTTO Ø mm 16 PERNO Ø mm 8 ALA SPESSORE mm 5  
 HINGE WITH TERMINALS AND BALL BEARINGS WITH SLEEVE Ø 16 mm PIN Ø 8 mm WING THICKNESS 5 mm

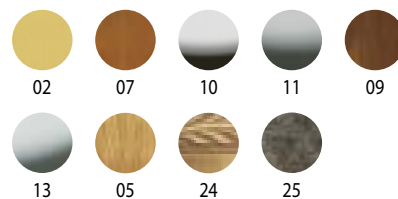
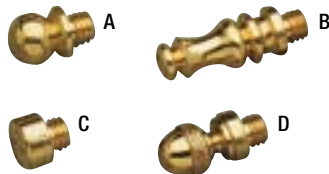

mm	PEZZI	OLV	OBV ANT OBGR BR-YESTER ORO\VAL	OCR	CRSAT	NIK\SAT FERVANT
102X76	2	26,25	27,50	32,50	33,00	33,50
102X89	2	27,00	28,50	33,25	33,75	34,25
102X102	2	28,75	29,75	35,00	35,50	36,00
126X89	2	41,25	42,50	48,75	49,25	49,75
126X202	2	43,75	45,00	51,25	51,75	52,25
152X89	2	50,00	52,50	60,00	60,50	61,00
152X102	2	55,00	56,25	63,75	64,25	64,75

• LA SCELTA DEI TERMINALI DEI TERMINALI A-B-C-D ANDRÀ SPECIFICATA AL MOMENTO DELL'ORDINE.  
 THE TYPE OF TERMINAL (A, B, C or D) MUST BE INDICATED IN THE INQUIRY.

\*\* EXTRA PREZZO PER BORDO TONDO 0,40 CAD. - EXTRA PRICE FOR ROUND EDGE € 0.40/pc.

**868** CERNIERA CON CUSCINETTI CON DECORO MODELLO CLASSIC  
 DECORATIVE HINGE WITH BALL BEARINGS MODEL "CLASSIC"

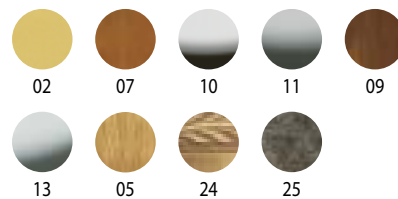

mm	PEZZI	OLV	OBV ANT OBGR BR-YESTER ORO\VAL	OCR	CRSAT	NIK\SAT FERVANT
152X89	2	43,75	45,00	46,25	47,50	48,75
102X76	2	31,25	32,25	34,50	35,75	37,00



**86 Z** CERNIERA ZANCATA CON TERMINALI E CUSCINETTI COMPLETA DI VITI CON CANOTTO Ø mm 12,5  
 CLAMP HINGE WITH TERMINALS AND BALL BEARINGS WITH SCREWS AND SLEEVE Ø mm 12,5

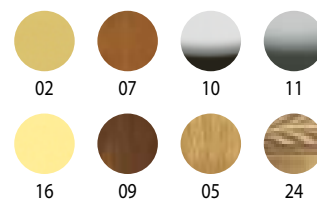
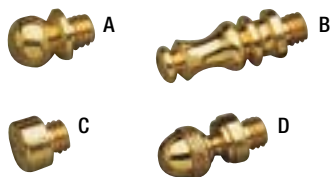

mm	PEZZI	OLV	OBV ANT OBGR BR-YESTER OROWAL	OCR	CRSAT	NIKISAT FERVANT	ORO
76	4	21,00	21,53	25,20	26,25	26,78	28,88
89	4	23,10	23,63	27,30	28,35	28,88	30,87
102	4	25,73	26,25	29,93	30,98	31,50	33,60
126	3	28,35	28,88	33,08	34,13	37,28	37,28

• LA SCELTA DEI TERMINALI DEI TERMINALI A-B-C-D ANDRÀ SPECIFICATA AL MOMENTO DELL'ORDINE.  
 THE TYPE OF TERMINAL (A, B, C or D) MUST BE INDICATED IN THE INQUIRY.

**86 F** CERNIERA CON TERMINALI E CUSCINETTI COMPLETA DI VITI IN FERRO  
 HINGE WITH TERMINALS AND BALL BEARINGS WITH IRON SCREWS

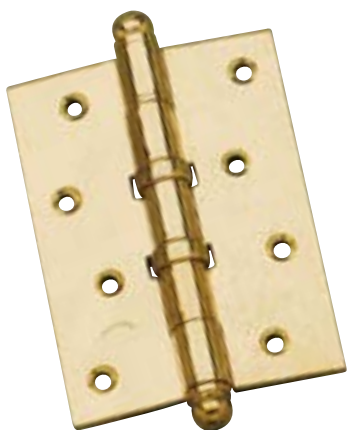

mm	PEZZI	OLV	OBV	OCR	CRSAT
76X63	2	2,55	2,91	3,08	3,15
76X76	2	2,63	3,21	3,40	3,50
89X76	2	3,01	3,36	3,50	3,85
89X89	2	3,36	3,66		
102X76	2	3,78	4,03	4,20	4,38
102X89	2	3,85	4,38	4,73	4,90

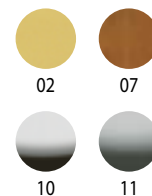

**160** CERNIERA A LIBRO REGOLABILE BREVETTATA CON CUSCINETTO (BREV. BS A 000001) DX-SX  
 PATENTED ADJUSTABLE BOOK HINGE WITH BALL BEARING (PATENT BS A 000001) RIGHT – LEFT



mm	PEZZI	OLV	OBV
76X76	2	14,00	14,00
89X76	2	15,80	15,80

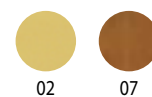

**165** CERNIERA A LIBRO CON CUSCINETTO DX-SX  
 BOOK HINGE WITH BALL VEARING RIGHT-LEFT



mm	PEZZI	OLV	OBV
76X76	2	13,00	13,00
89X76	2	14,50	14,50



**170** CERNIERA A LIBRO BAROCCO CON CUSCINETTO DX-SX  
 BAROQUE BOOK HINGE WITH BALL BEARING RIGHT-LEFT

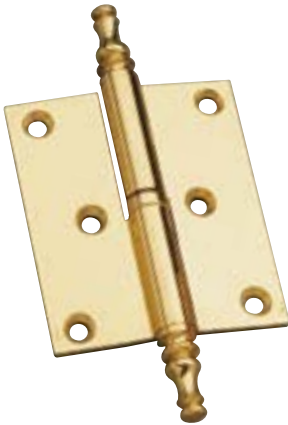

mm	PEZZI	OLV	OBV
76X76	2	14,00	14,00
89X76	2	15,80	15,80



**171** CERNIERA IN GROSSEZA CON CUSCINETTO DX-SX  
 KEY HINGE WITH BALL BEARINGS RIGHT-LEFT

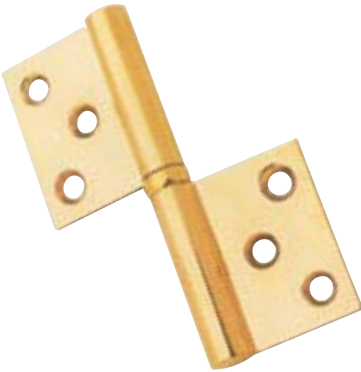

mm	PEZZI	OLV	OBV
100	2	10,50	10,50

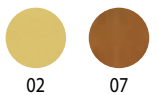

**172** CERNIERA IN GROSSEZA BAROCCO CON CUSCINETTO DX-SX  
 BAROQUE KEY HINGE WITH BALL BEARINGS RIGHT-LEFT

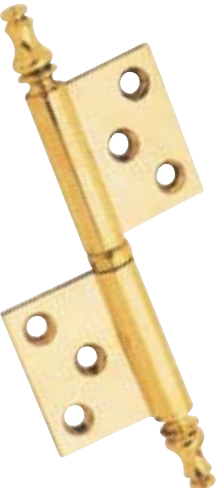

mm	PEZZI	OLV	OBV
100	2	12,50	12,50



**869** CERNIERA A BIETTA CON PIRAMIDE DX-SX  
BIETTA HINGE WITH BALL BEARINGS AND PYRAMID RIGHT-LEFT



mm	PEZZI	OLV	ANT OBGR BR-YESTER	OCR	CRSAT	NIKISAT FERVANT
90X60	2	13,00	14,00	16,25	17,50	18,75
100X70	2	16,25	19,50	21,25	22,50	23,75

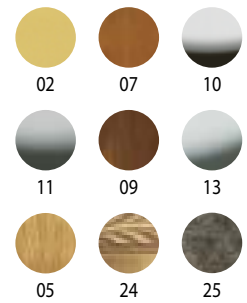

**55** CERNIERA PAUMELLES DX-SX  
PAUMELLES HINGE RIGHT-LEFT



mm	PEZZI	OL	OB	OCR	CRSAT	BRVANT	OLV
80X50	24	11,38	12,39	16,03	17,64	18,27	18,27
100X55	12	11,83	13,09	16,94	18,76	19,32	19,32
100X60	12	12,39	13,65	17,50	19,74	20,16	20,16
120X60	12	12,95	14,20	18,06	20,30	21,14	21,14
120X75	12	13,44	14,77	18,69	20,93	21,63	21,63
140X70	12	14,24	15,89	21,00	21,91	22,61	22,61
140X80	12	15,05	16,73	21,84	22,75	23,45	23,45

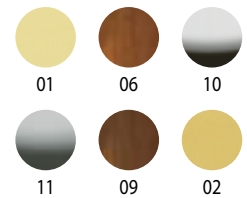

**55 B** CERNIERA PAUMELLES BORDO TONDO DX-SX  
PAUMELLES HINGE ROUND EDGE RIGHT-LEFT



mm	PEZZI	OL	OB	OCR	CRSAT	BRVANT	OLV
100X60	12	12,67	13,93	17,64	20,02	20,44	20,44
120X60	12	13,51	14,77	18,62	20,86	21,70	21,70
120X75	12	14,07	15,47	19,88	21,70	22,40	22,40
140X70	12	14,77	16,45	21,56	22,47	23,17	23,17
140X80	12	16,17	18,69	22,40	23,17	24,01	24,01

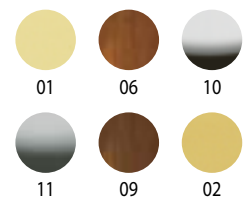

**56** CERNIERA A LIBRO DX-SX  
BOOK HINGE RIGHT-LEFT

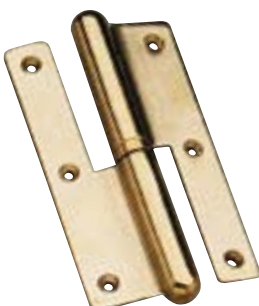

mm	PEZZI	OL	OB	OCR	CRSAT	BRVANT	OLV
100X65	12	13,51	15,05	18,41	20,44	21,35	21,35
120X70	12	14,63	16,45	21,70	23,59	24,22	24,22
140X75	12	19,53	21,35	27,45	29,61	30,24	30,24
160X80	12	20,51	22,19	28,91	31,15	31,71	31,71

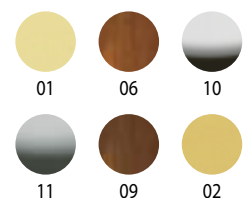

**56 B** CERNIERA A LIBRO BORDO TONDO DX-SX  
BOOK HINGE ROUND EDGE RIGHT-LEFT



mm	PEZZI	OL	OB	OCR	CRSAT	BRVANT	OLV
100X65	12	14,56	16,10	19,81	21,63	22,40	22,40

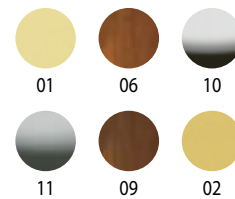

**57** CERNIERA A BIETTA DX-SX  
BIETTA HINGE RIGHT-LEFT

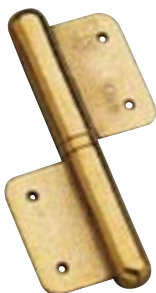

mm	PEZZI	OL	OB	OCR	CRSAT	BRVANT	OLV
100	12	13,72	15,12	19,18	20,79	21,56	21,56
120	12	14,21	15,68	20,26	21,66	22,40	22,40
140	12	16,80	18,27	23,87	25,41	26,11	26,11

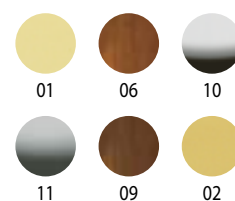

**58** CERNIERA IN GROSSEZA DX-SX  
KEYHINGE RIGHT-LEFT



mm	PEZZI	OL	OB	OCR	CRSAT	BRVANT	OLV
100	12	12,32	13,79	16,73	18,62	19,39	19,39
120	12	13,79	15,26	18,62	20,65	21,35	21,35
140	12	16,38	17,85	21,56	22,96	24,15	24,15

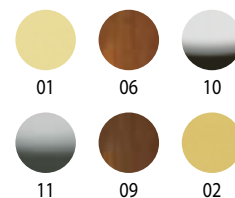

**59** CERNIERA A LIBRO CON PIRAMIDI DX-SX  
BOOK HINGE WITH PYRAMIDS RIGHT-LEFT



mm	PEZZI	OL 2019	OB 2019	OCR 2019	CRSAT 2019	BRVANT 2019	OLV 2019
100X65	12	14,56	16,38	19,95	21,77	22,54	22,54
120X70	12	15,54	17,36	22,47	24,29	25,13	25,13

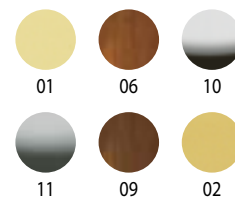

**59 B** CERNIERA A LIBRO CON PIRAMIDI BORDO TONDO DX-SX  
 BOOK HINGE WITH PYRAMIDS ROUND EDGE RIGHT-LEFT



mm	PEZZI	OL 2019	OB 2019	OCR 2019	CRSAT 2019	BRVANT 2019	OLV 2019
100X65	12	15,12	16,94	20,51	22,47	23,24	23,24

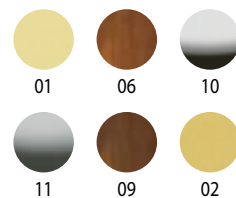

**60** CERNIERA PAUMELLES CON PIRAMIDE DX-SX  
 PAUMELLES HINGE WITH PYRAMID RIGHT-LEFT



mm	PEZZI	OL 2019	OB 2019	OCR 2019	CRSAT 2019	BRVANT 2019	OLV 2019
100X55	12	12,60	14,04	17,71	19,53	20,23	21,33
100X60	12	12,95	14,42	18,41	20,30	21,00	21,00
120X60	12	13,86	15,33	19,25	21,00	21,77	21,77
120X75	12	14,35	16,10	19,95	21,77	22,47	22,47
140X70	12	15,33	16,87	20,72	22,54	23,31	23,31
140X80	12	16,10	17,64	21,49	23,31	24,08	24,08

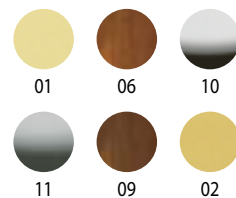

**60 B** CERNIERA PAUMELLES CON PIRAMIDI E BORDO TONDO DX-SX  
 PAUMELLES HINGE WITH PYRAMIDS AND ROUND EDGE RIGHT-LEFT

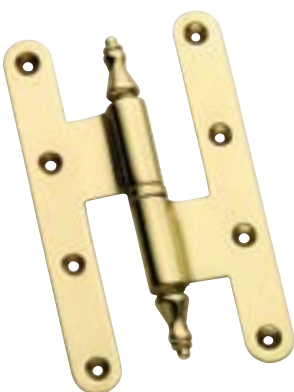

mm	PEZZI	OL	OB	OCR	CRSAT	BRVANT	OLV
100X60	12	13,51	14,98	18,29	20,86	21,56	21,56
120X70	12	15,19	16,59	20,25	22,82	23,52	23,52
140X70	12	15,89	17,43	20,52	23,10	23,87	23,87
140X80	12	16,66	18,20	21,26	24,50	24,64	24,64

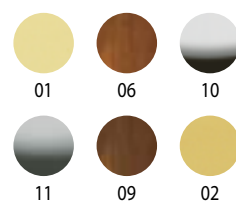

**61** CERNIERA IN GROSSEZA CON PIRAMIDE DX-SX  
 KEY HINGE WITH PYRAMID RIGHT-LEFT

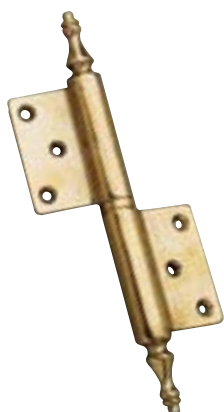

mm	PEZZI	OL	OB	OCR	CRSAT	BRVANT	OLV
100	12	13,51	15,19	19,46	21,28	22,05	25,05
120	12	14,42	16,10	20,79	22,68	23,45	23,45
140	12	16,80	18,62	23,03	24,99	25,69	25,69

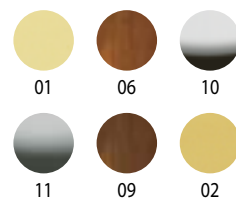

**62** CERNIERA ZANCATA DX-SX  
CLAMP HINGE RIGHT-LEFT

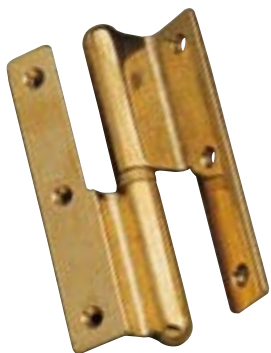

SOLO PER  
QUANTITÀ

mm	PEZZI	OL	OB	OCR	CRSAT	BRVANT	OLV
100X65	12	19,67	21,49	25,62	27,51	28,21	28,21
120X65	12	20,65	22,47	27,20	28,91	29,61	29,61
140X70	12	-	-	-	-	-	-

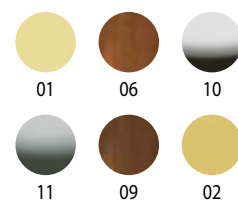

**63** CERNIERA A MASCHIETTO DX-SX  
T-HINGE MASCHIETTO RIGHT-LEFT



mm	PEZZI	OL	OB	OCR	CRSAT	BRVANT	OLV
190X100	6	21,21	23,59	30,94	32,34	31,43	31,43
190X120	6	25,27	27,93	34,65	36,89	35,63	35,63

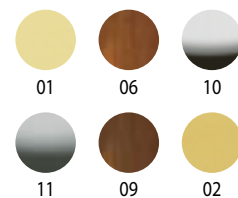

**64** CERNIERA ASCENSORE DX-SX  
HINGE FOR ELEVATOR RIGHT-LEFT

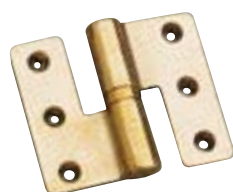

mm	PEZZI	OL	OB	OCR	CRSAT	BRVANT	OLV
65X80	12	13,23	14,77	18,48	20,30	21,07	21,07

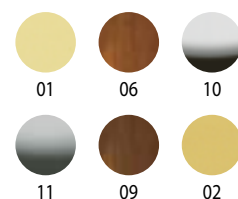

**863** CERNIERA A BANDELLA  
BANDELLA HINGE

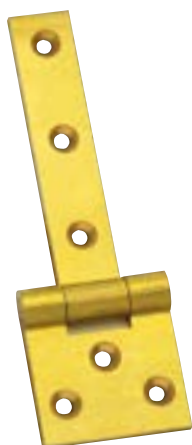

mm	PEZZI	OL
50X145	10	8,80



**864** CERNIERA A LIBRO D'IMPORTAZIONE COMPLETA DI VITI E CUSCINETTO DX-SX  
 BOOK HINGE WITH SCREWS AND BALL BEARINGS RIGHT-LEFT (imported product)



• AD ESAURIMENTO.  
 SUBJECT TO AVAILABILITY.

mm	PEZZI	OL
100X65	2	<b>8,14</b>
120X70	2	<b>8,80</b>



**865** CERNIERA A LIBRO CON BORDO TONDO D'IMPORTAZIONE COMPLETA DI VITI E CUSCINETTO DX-SX  
 BOOK HINGE WITH ROUND EDGE WITH SCREWS AND BALL BEARINGS RIGHT-LEFT (imported product)

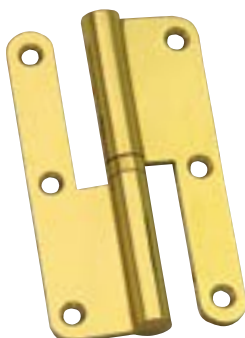

mm	PEZZI	OB	CRSAT	OLV
100X65	2	<b>7,77</b>	<b>8,40</b>	<b>7,77</b>
120X70	2	-	<b>9,45</b>	<b>8,40</b>

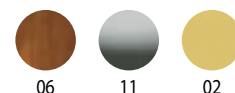

**866** CERNIERA CON CUSCINETTI D'IMPORTAZIONE IN ACCIAIO INOX COMPLETA DI VITI  
 STAINLESS STEEL HINGE WITH BALL BEARINGS AND SCREWS (imported product)



mm	PEZZI	INOX
76X63	2	<b>5,28</b>
76X76	2	<b>5,83</b>
89X76	2	<b>7,04</b>
102X76	2	<b>7,70</b>
102X89	2	<b>8,58</b>
102X102	2	<b>9,90</b>



**867** CERNIERA CON CUSCINETTI D'IMPORTAZIONE IN OTTONE COMPLETA DI VITI  
 BRASS HINGE WITH BALL BEARINGS AND SCREWS (imported product)

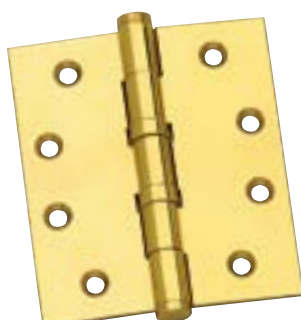

• AD ESAURIMENTO.  
 SUBJECT TO AVAILABILITY.

mm	PEZZI	OLV	OCR
76X63	2	5,50	<b>6,60</b>
76X76	2	6,49	<b>7,70</b>
89X76	2	8,25	<b>9,35</b>
102X76	2	9,24	<b>10,34</b>
102X89	2	9,90	<b>11,00</b>



**2500** CERNIERA A MOLLA DOPPIA AZIONE " TIPO BOMMER" IN ACCIAIO  
 DOUBLE ACTION SPRING HINGE "BOMMER TYPE" IN STEEL

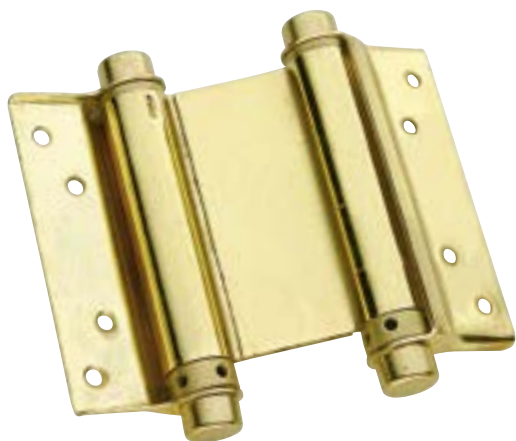

mm	PEZZI	OLV 2019	OB2019
75	2	17,31	<b>17,31</b>
100	2	20,51	<b>20,51</b>
125	2	27,20	<b>27,20</b>
150	2	35,91	<b>35,91</b>



**3500** CERNIERA A MOLLA DOPPIA AZIONE " TIPO BOMMER" IN ACCIAIO INOX  
 DOUBLE ACTION SPRING HINGE "BOMMER TYPE" IN STAINLESS STEEL



mm	PEZZI	INOX
75	2	<b>34,32</b>
100	2	<b>46,53</b>



**3498** CERNIERA A BARILOTTO CON CUSCINETTO  
 BARREL HINGE WITH BALL BEARING



mm	PEZZI	OL	OLV	CRSAT	OBGR
16X80	12	<b>9,00</b>	<b>11,96</b>	<b>13,40</b>	<b>12,10</b>

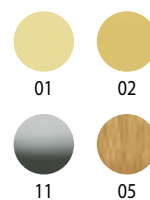

**3497** CERNIERA INVISIBILE BORDO TONDO  
 INVISIBLE HINGE ROUND EDGE



mm	PEZZI	CR/SAT-INOX
13x9x44	12	3,45
16x11x70	5	8,45
19x13x95	5	13,26
25x18x117	2	23,00



• AD ESAURIMENTO.  
 SUBJECT TO AVAILABILITY.



**2606** CERNIERA INVISIBILE IN PLASTICA E ZAMA  
INVISIBLE HINGE IN PLASTIC AND ZAMAK



• AD ESAURIMENTO.  
SUBJECT TO AVAILABILITY.

mm	PEZZI	
33X14X38	24	1,78

**2607** CERNIERA INVISIBILE IN ZAMA E FERRO ZINCATO  
INVISIBLE HINGE IN ZAMAK AND GALVANIZED IRON



• AD ESAURIMENTO.  
SUBJECT TO AVAILABILITY.

mm	PEZZI	
13X8X44	24	€1,70

**2620** CERNIERA INVISIBILE REGOLABILE SU DUE ASSI DX-SX  
INVISIBLE HINGE ADJUSTABLE ON TWO AXES RIGHT-LEFT

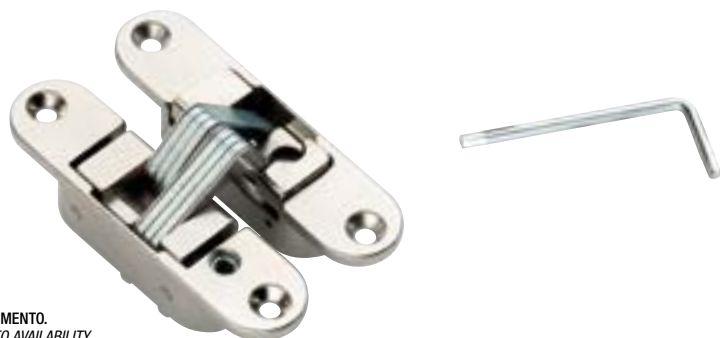

• AD ESAURIMENTO.  
SUBJECT TO AVAILABILITY.

mm	PEZZI	
23X13X95	2	20,60

**860** COPRICERNIERA LISCIO  
SMOOTH HINGE COVER



Ø mm	PEZZI	OLV	OCR	CRSAT	OBGR
14	24	2,90	3,30	3,30	3,10
16	24	3,02	4,00	4,00	3,22

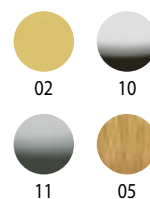

**81** COPRICERNIERA CON PIRAMIDE  
HINGE COVER WITH PYRAMID



Ø mm	PEZZI	OLV	OCR	CRSAT	OBGR
14	24	3,00	3,53	3,53	3,32
16	24	3,40	4,00	4,00	3,52

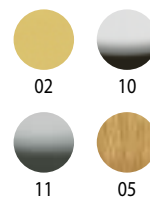

\* PER 200 PEZZI TUTTE LE MISURE - FOR 200 PCS ALL THE DIMENSIONS

**4** CERNIERA FRESATA PIANA IN OTTONE PROFILATO  
FLAT MILLED HINGE IN EXTRUDED BRASS

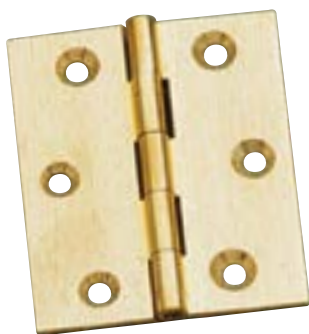

mm	PEZZI	OL	OB	O-NIK
25X25	24	0,76	1,00	1,40
30X25	24	0,72	0,94	1,34
30X30	24	0,74	1,00	1,40
35X30	24	0,82	1,08	1,58
35X35	24	0,84	1,10	1,60
40X30	24	0,90	1,14	1,64
40X35	24	0,92	1,16	1,68
40X40	24	0,98	1,26	1,82
50X40	24	1,12	1,40	1,94
50X50	24	1,38	1,68	2,36
60X50	24	1,62	1,96	2,66
70X55	24	2,42	2,82	3,76
80X60	24	3,12	3,64	4,10

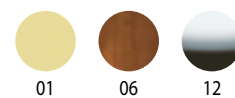

**5** CERNIERA MEZZA ZANCATA PIANA IN OTTONE PROFILATO  
HALF CLAMPED HINGE IN EXTRUDED BRASS

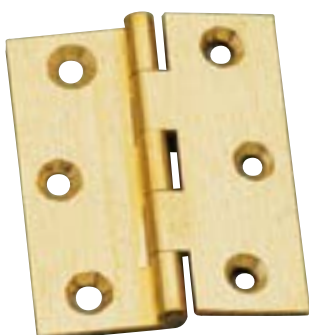

mm	PEZZI	OL	OB	O-NIK
35X35	24	1,04	1,38	1,72
40X35	24	1,04	1,38	1,72
40X40	24	1,14	1,50	1,88
50X40	24	1,34	1,72	2,14
50X50	24	1,58	1,98	2,46
60X50	24	1,80	2,26	2,86
70X55	24	2,92	3,28	4,10

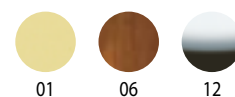

**6** CERNIERA FRESATA DOPPIA ZANCATA IN OTTONE PROFILATO  
DOUBLE CLAMPED MILLED HINGE IN EXTRUDED BRASS

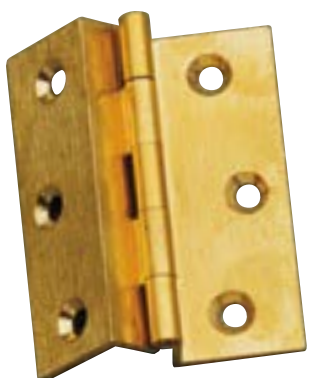

mm	PEZZI	OL	OB	O-NIK
35X35	24	1,22	1,60	2,00
40X35	24	1,22	1,60	2,00
40X40	24	1,34	1,70	2,12
50X40	24	1,58	2,00	2,46
50X50	24	1,76	2,20	2,66
60X50	24	2,14	2,64	3,22
70X55	24	3,20	3,66	4,24



**7** CERNIERA FRESATA PIANA CON ASOLE IN OTTONE PROFILATO  
FLAT MILLED HINGE WITH HOLES IN EXTRUDED BRASS

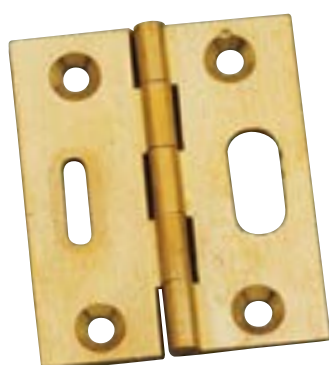

mm	PEZZI	OL	OB	O-NIK
40X40	24	1,39	1,66	2,00
50X40	24	1,62	1,93	2,20

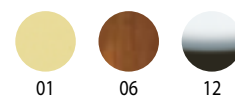

**8** CERNIERA FRESATA MEZZA ZANCATA CON ASOLE IN OTTONE PROFILATO  
 HALF CLAMPED MILLED HINGES WITH HOLES IN EXTRUDED BRASS



mm	PEZZI	OL	OB	O-NIK
40X40	24	1,60	2,00	2,80
50X40	24	2,00	2,40	3,20

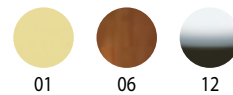

**9** CERNIERA FRESATA DOPPIA ZANCATA CON ASOLE IN OTTONE PROFILATO  
 DOUBLE CLAMPED MILLED HINGE WITH HOLES IN EXTRUDED BRASS

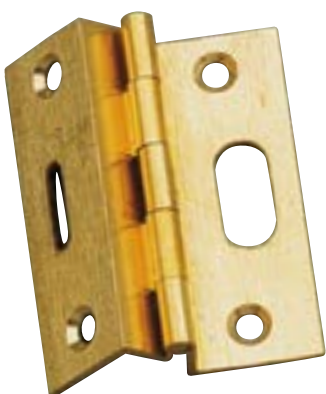

mm	PEZZI	OL	OB	O-NIK
40X40	24	1,60	2,00	2,80
50X40	24	2,00	2,40	3,20



**3350** CERNIERA IN OTTONE CON ASOLA  
 BRASS HINGE WITH HOLE

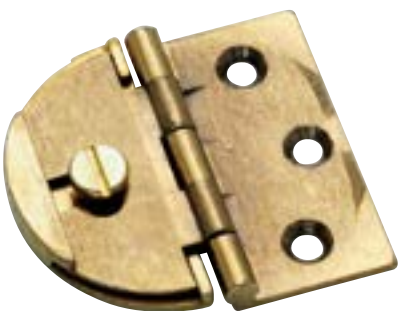

	mm	PEZZI	OL	OB	O-NIK
COLLO 0	40X40	24	1,39	1,62	1,88
COLLO 8	40X40	24	1,43	1,66	1,92
BASETTA		24	0,54	0,62	0,92

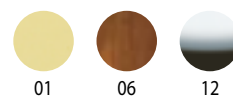

**3351** CERNIERA IN OTTONE CON ASOLA E FORI DI FISSAGGIO  
 BRASS HINGE WITH HOLE AND FIXING HOLES

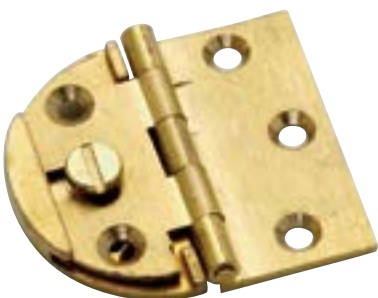

	mm	PEZZI	OL	OB	O-NIK
COLLO 0	40X40	24	1,58	1,81	2,07
COLLO 8	40X40	24	1,62	1,85	2,10
BASETTA		24	0,54	0,62	0,92

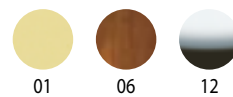

**3352** CERNIERA IN OTTONE CON ASOLE  
BRASS HINGE WITH HOLES



mm	PEZZI	OL	OB	O-NIK
50X40	24	1,62	2,00	2,26

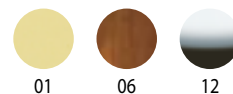

**21** CERNIERA RIGATA PIANA CON PIRAMIDE DX-SX  
FLAT STRIPED HINGE WITH PYRAMID RIGHT-LEFT

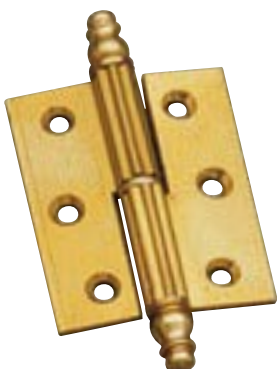

mm	PEZZI	OL	OB
40X40	24	2,14	2,45
50X40	24	2,40	2,70
60X40	24	2,80	3,20

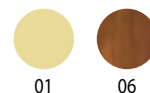

**22** CERNIERA RIGATA ZANCATA CON PIRAMIDE DX-SX  
CLAMPED HINGE WITH PYRAMID RIGHT-LEFT



mm	PEZZI	OL	OB
40X40	24	2,64	3,00
50X40	24	3,00	3,40
60X40	24	3,40	4,00

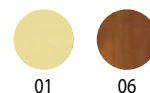

**21 C** CERNIERA LISCIA PIANA CON PIRAMIDE DX-SX  
SMOOTH FLAT HINGE WITH PYRAMID RIGHT-LEFT



mm	PEZZI	OL	OB
40X40	24	2,20	2,50
50X40	24	2,50	2,80
60X40	24	3,00	3,30

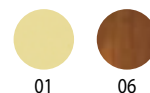

**22 C** CERNIERA LISCIA ZANCATA CON PIRAMIDE DX-SX  
SMOOTH CLAMPED HINGE WITH PYRAMID RIGHT-LEFT



mm	PEZZI	OL	OB
40X40	24	2,80	3,10
50X40	24	3,20	3,60



**19** CERNIERA PIANA CON PREMONTAGGIO  
FLAT HINGE WITH PRE-ASSEMBLY



mm	PEZZI	OL	OB	O-NIK
40X40	60	1,75	2,20	2,60
50X40	60	2,10	2,55	3,00

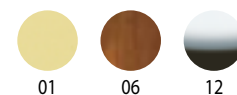

**19 C** CERNIERA ZANCATA CON PREMONTAGGIO  
CLAMPED HINGE WITH PRE-ASSEMBLY



mm	PEZZI	OL	OB
40X40	60	1,92	2,28
50X40	60	2,30	2,80

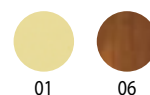

**18** CERNIERA BISCOTTO SENZA FERMO  
COOKIE HINGE WITHOUT STOP

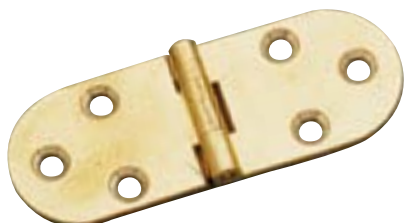

mm	PEZZI	OL	OB	O-NIK
30X80	24	2,00	2,40	2,80

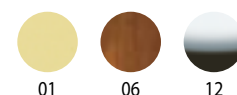

**29** CERNIERA TONDA CON FORI INTERNI O ESTERNI  
ROUND HINGE WITH INTERNAL OR EXTERNAL HOLES



mm	PEZZI	OL	OB	O-NIK
30X47	100	1,48	1,72	2,10

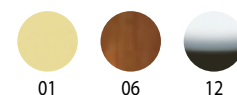

**173** CERNIERA A BISCOTTO  
COOKIE HINGE



mm	PEZZI	OL	OB	O-NIK
15X40	100	1,48	1,72	2,10

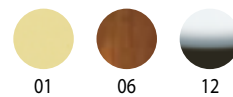

**30** CERNIERA BISCOTTO CON FERMO  
BISCUIT HINGE WITH STOP

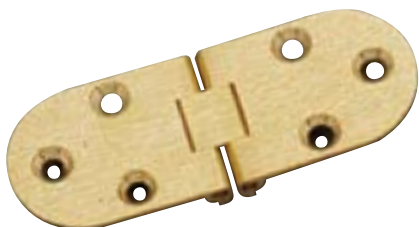

mm	PEZZI	OL	OB	OCR	CRSAT	OLV
30X80	24	2,80	3,20	3,54	4,40	3,88



**13** CERNIERA BAROCCO PIANA ALA QUADRA DX-SX  
BAROQUE FLAT HINGE SQUARE WINGS RIGHT-LEFT



mm	PEZZI	OL	OB
60X55	24	1,84	1,84



**13 B** CERNIERA BAROCCO PIANA ALA TONDA DX-SX  
BAROQUE FLAT HINGE ROUND WINGS RIGHT-LEFT



mm	PEZZI	OL	OB
60X55	24	1,84	1,84



**14** CERNIERA BAROCCO ZANCATA DX-SX  
BAROQUE CLAMPED HINGE RIGHT-LEFT



mm	PEZZI	OL	OB
60X55	24	2,07	2,07



**15** CERNIERA BAROCCO PIANA GRANDE DX-SX  
BIG FLAT BAROQUE HINGE RIGHT-LEFT



mm	PEZZI	OL	OB
90X60	24	3,68	3,68



**16** CERNIERA BAROCCO ZANCATA GRANDE DX-SX  
BIG CLAMPED BAROQUE HINGE RIGHT-LEFT.



mm	PEZZI	OL	OB
90X60	24	4,14	4,14



**25** CERNIERA BAROCCO PIANA PICCOLA DX-SX  
SMALL FLAT BAROQUE HINGE RIGHT-LEFT



mm	PEZZI	OL	OB
50X40	24	1,84	1,84



**26** CERNIERA CON LATI DISUGUALI E PIRAMIDI DX-SX  
HINGE WITH PYRAMIDS AND UNEQUAL SIDES RIGHT-LEFT.

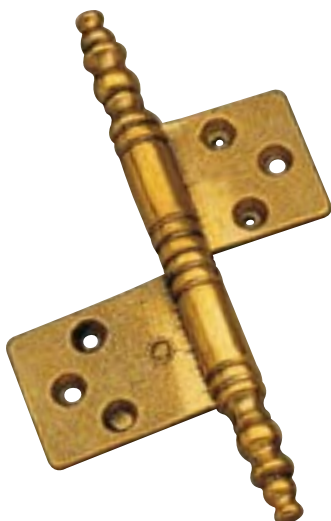

mm	PEZZI	OL	OB
120	24	5,52	5,52

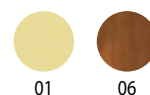

**95** CERNIERA CON BORDI TONDI CANNOTO Ø mm 8  
HINGE WITH ROUND EDGE SLEEVE Ø mm 8

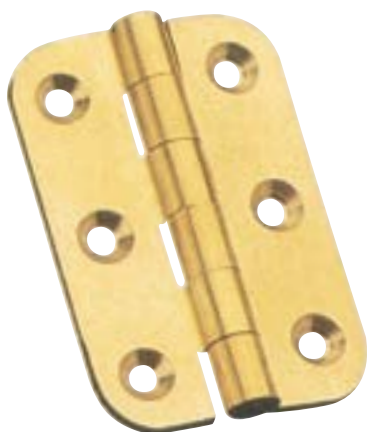

mm	PEZZI	OL	OB
60X42	24	2,89	3,26
80X60	24	4,10	4,41



**96** CERNIERA CON TERMINALI CANNOTO Ø mm 10  
HINGE WITH TERMINALS SLEEVE Ø mm 10

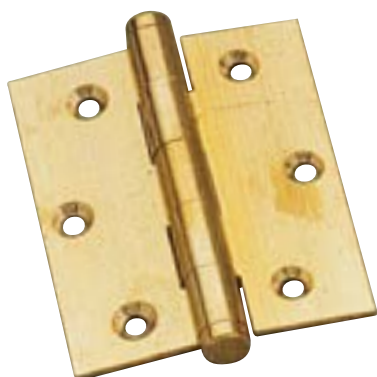

mm	PEZZI	OL	OB
63X50	40	3,80	4,20
76X63	20	6,00	6,70



**96 B** CERNIERA CON TERMINALI E BORDI TONDI CANNOTO Ø mm 10 E PERNO IN INOX  
HINGE WITH TERMINALS AND ROUND EDGE SLEEVE Ø mm 10 AND STAINLESS STEEL PIN



mm	PEZZI	OL	OB
60X50	40	4,50	5,00



**10** CERNIERA SFILARE PIANA DX-SX  
REMOVABLE FLAT HINGE RIGHT-LEFT



mm	PEZZI	OL	OB	O-NIK
40X40	24	1,40	1,80	2,20
50X40	24	1,80	2,20	2,60
60X40	24	2,30	2,70	3,10

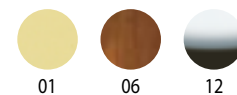



**11** CERNIERA SFILARE MEZZE ZANCATE DX-SX  
 HALF CLAMPED REMOVABLE HINGE RIGHT-LEFT



mm	PEZZI	OL	OB	O-NIK
40X40	24	1,80	2,20	2,60

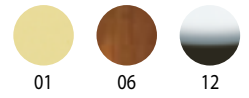

**12** CERNIERA SFILARE DOPPIE ZANCATE DX-SX  
 DOUBLE CLAMPED REMOVABLE HINGE RIGHT-LEFT



mm	PEZZI	OL	OB	O-NIK
40X40	24	1,80	2,20	2,60

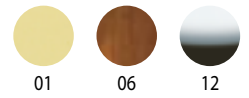

**150** CERNIERA CILINDRICA  
 CYLINDRICAL HINGE



mm	PEZZI	OL
10	24	2,99
12	24	2,99
14	24	3,14
16	24	4,04
18	24	5,21
24	24	11,18



**840** CERNIERA IN FERRO ZINGATO PESANTE PERNO LEVABILE  
 HEAVY ZINC-PLATED HINGE IN IRON WITH REMOVABLE PIN



mm	PEZZI	FERRO 2019
40X35X1,2	24	0,97
45X35X1,2	24	1,03
50X40X1,3	24	1,14
57X40X1,3	24	1,29
63X45X1,3	24	1,38
70X50X1,3	24	1,60
75X50X1,3	24	1,68
86X55X1,5	24	2,22
100X70X1,6	24	2,86
115X70X1,8	24	2,89



**808** CERNIERA IN FERRO ZINGATO PESANTE PERNO LEVABILE  
HEAVY ZINC-PLATED HINGE IN IRON WITH REMOVABLE PIN



mm	PEZZI	FERRO
50X50X1,6	24	1,67
65X65X2	24	2,46
75X65X2	24	3,38
75X75X2,0	24	3,67
90X75X2,5	12	5,75
90X90X2,5	12	6,13
100X90X2,5	12	7,49
100X100X2,5	12	12,12
125X125X3	6	17,69



FERRO

**3322** CERNIERA PIANA MEZZA QUADRA ACCIAIO INOX 18\8 LUCIDO PERNO RASATO IN OTTONE  
FLAT HALF SQUARE HINGE IN POLISHED STAINLESS STEEL 18\8 AND WITH BRASS PIN



mm	PEZZI	INOX
30X22X0,8	24	1,40
30X30X0,8	24	1,43
40X32X0,8	24	2,04
50X40X1,0	24	2,22
60X50X1,0	24	2,55



INOX

**3838** CERNIERA PESANTE ACCIAIO INOX 18\8 LUCIDO PERNO FISSO  
HEAVY HINGE IN POLISHED STAINLESS STEEL 18\8 AND WITH FIXED PIN



mm	PEZZI	INOX
50X38X1,5	24	3,55
63X40X1,5	24	4,75
75X50X2,0	12	6,23
85X60X2,0	12	8,31
100X75X2,0	12	10,78



INOX

**2050** CERNIERA LEGGERE IN FERRO OTTONATO PER COFANETTI  
LIGHT BRASSED IRON HINGE FOR BOXES

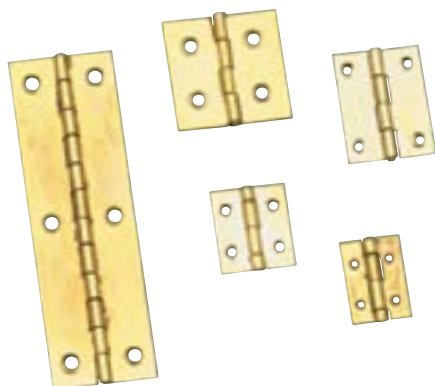

mm	PEZZI	FERRO
10X16X0,5	100	0,11
13X15X0,5	100	0,11
13X20X0,5	100	0,13
15X20X0,5	100	0,13
15X25X0,5	100	0,15
15X30X0,5	100	0,15
15X40X0,5	100	0,20
18X30X0,5	100	0,15
18X60X0,5	100	0,26
20X20X0,6	100	0,15
20X30X0,6	100	0,18



FERRO  
OTTONATO

**3323** CERNIERA PIANA STRETTA ACCIAIO INOX 18\8 LUCIDO PERNO FISSO  
*NARROW FLAT HINGE IN POLISHED STAINLESS STEEL 18\8 AND WITH FIXED PIN*



mm	PEZZI	INOX
30X20X0,8	24	1,23
35X22X0,8	24	1,32
40X25X0,8	24	1,36
50X30X1,0	24	1,69
60X35X1,0	24	2,20
70X40X1,2	24	3,20
80X45X1,2	24	4,55
90X50X1,5	24	6,71
100X50X1,5	24	7,71



**3317** CERNIERA PIANA QUADRA ACCIAIO INOX 18\8 LUCIDO PERNO FISSO  
*SQUARE FLAT HINGE IN POLISHED STAINLESS STEEL 18\8 AND WITH FIXED PIN*

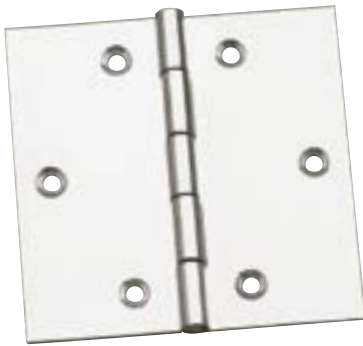

mm	PEZZI	INOX
30X30X0,8	24	1,30
40X40X0,8	24	1,97
50X50X1,0	24	2,38
60X60X1,0	24	3,05
70X70X1,2	24	5,26
80X80X1,2	24	5,82



**3316** CERNIERA PIANA RETTANGOLARE ACCIAIO INOX 18\8 LUCIDO PERNO FISSO  
*RECTANGULAR FLAT HINGE IN POLISHED STAINLESS STEEL 18\8 AND WITH FIXED PIN*

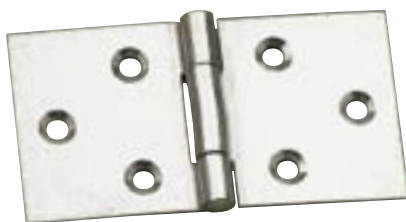

mm	PEZZI	INOX
50X95X1,5	10	5,54



**3318** CERNIERA SAGOMATA EXTRA PESANTE ACCIAIO INOX 18\8 LUCIDO PERNO FISSO  
*EXTRA HEAVY SHAPED HINGE IN POLISHED STAINLESS STEEL 18\8 AND WITH FIXED PIN*



mm	PEZZI	INOX
32X86X2,0(*)24	24	7,63
65X180X2,5	10	15,26

(\*) In AISI 316



**3370** CERNIERA SAGOMATA TIPO NAUTICA ACCIAIO INOX 18\8 LUCIDO PERNO FISSO  
*NAUTICAL SHAPED HINGE IN POLISHED STAINLESS STEEL 18\8 AND WITH FIXED PIN*



mm	PEZZI	INOX
40X42x1,5	24	<b>4,07</b>



INOX

**3374** CERNIERA SAGOMATA TIPO NAUTICA ACCIAIO INOX 18\8 LUCIDO PERNO FISSO  
*NAUTICAL SHAPED HINGE IN POLISHED STAINLESS STEEL 18\8 AND WITH FIXED PIN*



mm	PEZZI	INOX
40X70x1,5	24	<b>4,19</b>



INOX

**1285** CERNIERA RUSTICA IN FERRO BRUNITO  
*RUSTIC HINGE IN BURNISHED IRON*



mm	PEZZI	FERRO 2019
70X40X1,6	25	<b>1,22</b>



FERRO NERO

**1295** CERNIERA RUSTICA IN FERRO BRUNITO  
*RUSTIC HINGE IN BURNISHED IRON*



mm	PEZZI	FERRO
70X110X1,6	25	<b>1,38</b>



FERRO NERO





**MANIGLIONI**  
*pull handles*

**101** MANIGLIONE URANO  
URANO HANDLE



mm	PEZZI	OLV	OBGR
230	2	70,69	70,69
280	2	81,18	81,18

**102** MANIGLIONE AZZURA  
AZZURA HANDLE

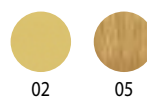

mm	PEZZI	OLV	OBGR
180	2	37,74	37,74

**117** MANIGLIONE BAROCCO  
BAROQUE HANDLE

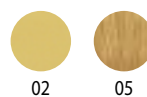

mm	PEZZI	OLV	OBGR
250	2	84,59	84,59

**2017** MANIGLIONE SFERA  
SFERA HANDLE

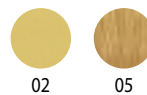
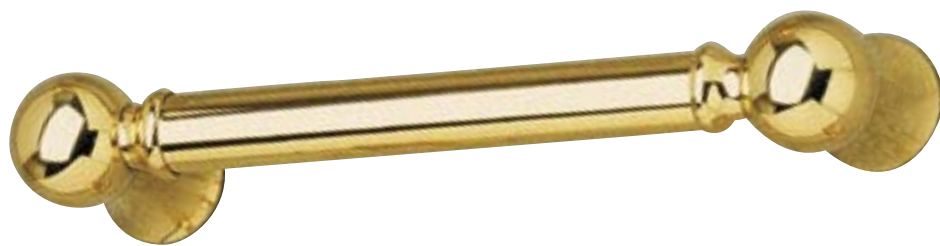

mm	PEZZI	OLV	OBGR
230	2	61,39	61,39

**2017 B** MANIGLIONE RICURVO  
SFERA HANDLE CURVED



mm	PEZZI	OLV	OBGR
230	2	73,12	73,12

**2018** MANIGLIONE SIRIO  
SIRIO HANDLE



mm	PEZZI	OLV	OBGR
250	2	42,11	42,11

**2018 B** MANIGLIONE SIRIO ZANCATO  
SIRIO CLAMPED HANDLE



mm	PEZZI	OLV	OBGR
250	2	46,88	46,88



**2068** MANIGLIONE DIRITTO INOX Ø 32 INTERASSE 350 mm  
 STAINLESS STEEL STRAIGHT HANDLE Ø 32 mm



INOX

	mm	PEZZI	INOX	
SINGOLO	350	1	<b>41,80</b>	
COPPIA	350	1	<b>70,40</b>	
KIT MONTAGGIO PER COPPIA VETRO		1		<b>8,91</b>
KIT MONTAGGIO SINGOLO		1		<b>4,95</b>

**2069** MANIGLIONE ZANCATO INOX Ø 32 INTERASSE 350 mm  
 STAINLESS STEEL CLAMPED HANDLE Ø 32 mm



INOX

	mm	PEZZI	INOX	
SINGOLO	350	1	<b>44,00</b>	
COPPIA	350	1	<b>77,00</b>	
KIT MONTAGGIO PER COPPIA VETRO		1		<b>8,91</b>
KIT MONTAGGIO SINGOLO		1		<b>4,95</b>

**2070** MANIGLIONE ELLISSE INOX Ø 32 INTERASSE 350 mm  
 ELLISSE HANDLE IN STAINLESS STEEL Ø 32 mm



INOX

	mm	PEZZI	INOX	
SINGOLO	350	1	<b>46,20</b>	
COPPIA	350	1	<b>82,50</b>	
KIT MONTAGGIO PER COPPIA VETRO		1		<b>8,91</b>
KIT MONTAGGIO SINGOLO		1		<b>4,95</b>

**2071** MANIGLIONE TRIANGOLO IN ACCIAIO INOX Ø 32 mm  
 STAINLESS STEEL TRIANGLE HANDLE Ø 32 mm

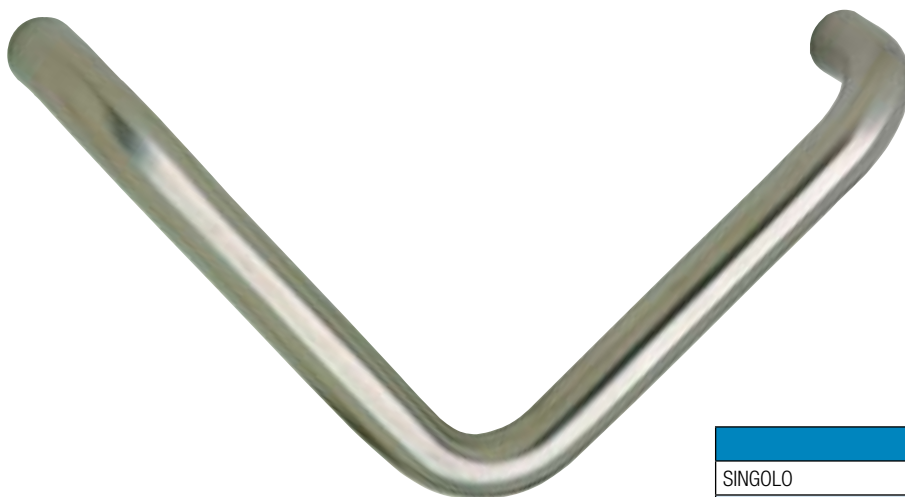

	mm	PEZZI	INOX	
SINGOLO	350	1	46,20	
COPPIA	350	1	82,50	
KIT MONTAGGIO PER COPPIA VETRO		1		8,91
KIT MONTAGGIO SINGOLO		1		4,95

**655** MANIGLIONE BRAHMA DIRITTO  
 BRAHMA STRAIGHT HANDLE



mm	PEZZI	OLV	OBGR
	2	67,57	67,57

**650** MANIGLIONE BRAHMA ZANCATO  
 BRAHMA CLAMPED HANDLE



mm	PEZZI	OLV	OBGR
	2	71,50	71,50

**597** MANIGLIONE LAGUNA  
LAGUNA HANDLE

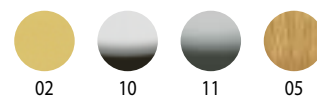

mm	PEZZI	OLV	OCR	CRSAT	OBGR
	2	46,78	52,03	52,80	46,78

**690** MANIGLIONE MILLENIUM SENZA ROSETTE  
MILLENIUM HANDLE WITHOUT COVER ROSE

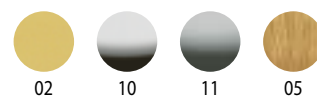

mm	PEZZI	OLV	OCR	CRSAT	OBGR
	2	67,54	73,70	74,25	67,54

**691** MANIGLIONE MILLENIUM CON ROSETTE  
MILLENIUM HANDLE WITH COVER ROSE

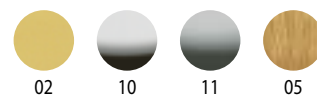

mm	PEZZI	OLV	OCR	CRSAT	OBGR
	2	72,77	77,99	78,85	72,77

**1142** MANIGLIONE FOGLIE  
FOGLIE HANDLE



mm	PEZZI	OLV	ANT	OBGR	BRVETER
312	2	92,40	97,35	92,40	97,35

**2090** MANIGLIONE SPAGNA  
SPAGNA HANDLE

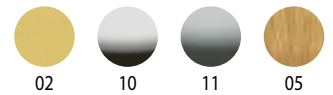

• Sistema di montaggio per maniglioni art. A.

mm	PEZZI	OLV	OCR	CRSAT	OBGR
160	4	15,98	17,64	17,64	15,98
200	4	17,60	18,74	18,74	17,60

**2091** MANIGLIONE SOFIA  
SOFIA HANDLE

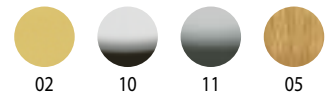

• Sistema di montaggio per maniglioni art. A.

mm	PEZZI	OLV	OCR	CRSAT	OBGR
200	2	31,79	34,98	34,98	31,79

**2092** MANIGLIONE ZANCATO SOFIA  
SOFIA CLAMPED HANDLE

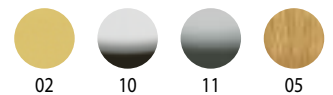

• Sistema di montaggio per maniglioni art. A.

mm	PEZZI	OLV	OCR	CRSAT	OBGR
200	2	34,43	37,60	37,60	34,43

**2093** MANIGLIONE SOFIA BICOLORE  
SOFIA BICOLOR HANDLE

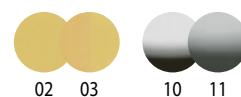

mm	PEZZI	OLV\OLS	OCR\CRSAT
200	2	37,00	40,10

• Sistema di montaggio per maniglioni art. A.

**2094** MANIGLIONE ZANCATO SOFIA BICOLORE  
SOFIA BICOLOR CLAMPED HANDLE

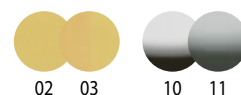

mm	PEZZI	OLV\OLS	OCR\CRSAT
200	2	39,59	42,68

• Sistema di montaggio per maniglioni art. A.

**2095** MANIGLIONE ZANCATO ONDA  
ONDA CLAMPED HANDLE

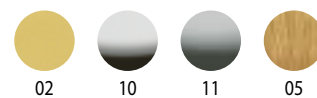

mm	PEZZI	OLV	OCR	CRSAT	OBGR
	2	18,01	19,65	19,65	18,01

• Sistema di montaggio per maniglioni art. A.

**2609** MANIGLIONE DENISE  
DENISE HANDLE

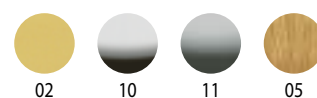

mm	PEZZI	OLV	OCR	CRSAT	OBGR
	2	31,85	33,97	33,97	31,85

**2610** MANIGLIONE DENISE 2 BICOLOR  
DENISE 2 BICOLOR HANDLE

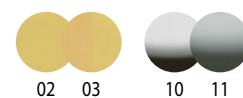

mm	PEZZI	OLVOLS	OCR\CRSAT
	2	35,40	37,53

**2611** MANIGLIONE ESSE  
ESSE HANDLE

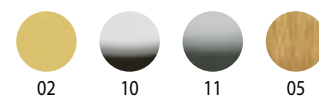

mm	PEZZI	OLV	OCR	CRSAT	OBGR
	2	31,85	33,97	33,97	31,85

**2612** MANIGLIONE TORCIGLIONE  
TORCIGLIONE HANDLE

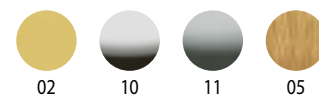

mm	PEZZI	OLV	OCR	CRSAT	OBGR
	2	31,74	33,97	33,97	31,85

**2613** MANIGLIONE MARGHERITA  
MARGHERITA HANDLE

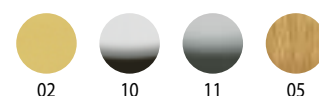

mm	PEZZI	OLV	OCR	CRSAT	OBGR
	2	80,43	92,95	92,95	80,43

**2410** MANIGLIONE ASTI  
ASTI HANDLE

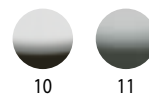

mm	PEZZI	OCR	CRSAT
210	2	54,68	46,61
250	2	75,87	73,71

**A** SISTEMA DI MONTAGGIO PER MANIGLIONI  
MOUNTING SYSTEM FOR HANDLES



**B** SISTEMA DI MONTAGGIO PER MANIGLIONI  
MOUNTING SYSTEM FOR HANDLES

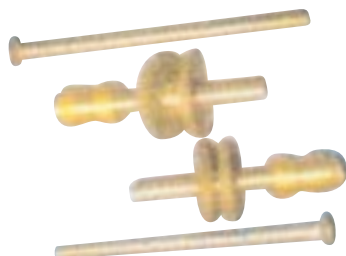



**MANIGLIE**  
*door handles*



**1260** MANIGLIA BASTONCINO  
BASTONCINO HANDLE

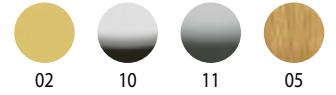

	PEZZI	OLV	OCR	CRSAT	OBGR
CON PLACCA	2	24,03	24,03	24,03	24,71
CON ROSETTA	2	17,82	17,82	17,82	18,36
DK	4	10,94	10,94	10,94	11,34
CREMONESE	4	17,82	20,66	20,66	19,04
CON PLACCA	2	26,33	26,33	26,33	27,14
CON ROSETTA	2	20,25	20,25	20,25	21,20
DK	4	12,15	12,15	12,15	12,68

**1270** MANIGLIA AZZURRA  
AZZURRA HANDLE

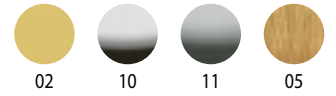

	PEZZI	OLV	OCR	CRSAT
CON PLACCA	2	31,19	31,19	31,19
CON ROSETTA	2	25,11	25,11	25,11
DK	4	14,58	14,58	14,58
CREMONESE	4	26,19	26,19	26,19

**1300** MANIGLIA MARTINA  
MARTINA HANDLE

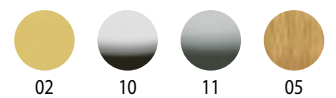

	PEZZI	OLV	OCR	CRSAT	OBGR
CON PLACCA	2	24,71	24,71	24,71	25,52
CON ROSETTA	2	18,63	18,63	18,63	19,44
DK	4	11,34	11,34	11,34	11,75

**1320** MANIGLIA GOCCIA  
GOCCIA HANDLE

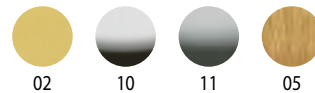

	PEZZI	OLV	OCR	CRSAT	OBGR
CON PLACCA	2	24,71	24,71	24,71	25,52
CON ROSETTA	2	18,63	18,63	18,63	19,44
DK	4	11,34	11,34	11,34	11,75
CREMONESE	4	17,82	20,66	20,66	19,04

**1330** MANIGLIA ANTIK  
ANTI-K HANDLE

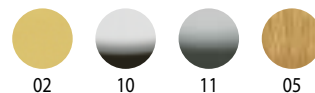

	PEZZI	OLV	ANT	BR\YESTER	FERVANT
CON PLACCA	2	52,26	53,10	53,10	65,21
CON ROSETTA AVITARE	2	52,26	53,10	53,10	65,21
DK	4	27,27	27,95	27,95	34,02

**1340** MANIGLIA RICCIO  
RICCIO HANDLE

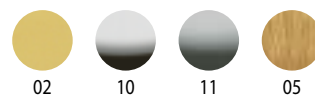

	PEZZI	OLV	OBGR	BR\YESTER	ORO /24K
CON PLACCA	2	53,46	53,46	53,46	77,90
CON ROSETTA AVITARE	2	53,46	53,46	53,46	77,90
DK	4	27,54	27,54	27,54	39,69

**1370** MANIGLIA LUXOR  
LUXOR HANDLE

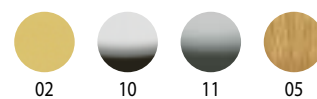

	PEZZI	OLV	OCR	CRSAT	OBGR
CON PLACCA	2	31,59	31,59	31,59	32,54
CON ROSETTA AVVITARE	2	36,45	36,45	36,45	37,40
CON ROSETTA	2	25,52	25,52	25,52	26,33
DK	4	39,56	39,55	39,55	39,56

**1380** MANIGLIA LUXOR 2 BICOLOR  
LUXOR 2 BICOLOR HANDLE

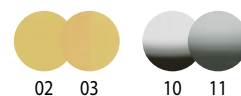

	PEZZI	OLV\OSV	OCR\CRS	NIK\NIK-S
CON PLACCA	2	35,64	35,64	38,88
CON ROSETTA AVVITARE	2	40,50	40,50	43,88
CON ROSETTA	2	29,70	29,70	32,81
DK	4	17,01	17,01	18,63

**1400** MANIGLIA DIVA  
DIVA HANDLE

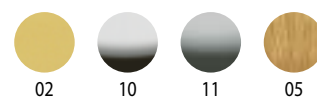

	PEZZI	OLV	OCR	CRSAT	OBGR
CON PLACCA	2	36,45	36,45	36,45	37,26
CON ROSETTA AVVITARE	2	37,26	37,26	37,26	38,21
CON ROSETTA	2	26,87	26,87	26,87	27,14
DK	4	15,53	15,53	15,53	15,80

**1410** MANIGLIA DIVA 2 BICOLOR  
DIVA 2 HANDLE BICOLOR

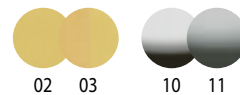

	PEZZI	OLVOSV	OCRVCRS	NIKNIK-S
CON PLACCA	2	40,04	40,04	43,87
CON ROSETTA AVVITARE	2	41,31	41,31	44,55
CON ROSETTA	2	30,38	30,38	33,62
DK	4	17,42	17,42	19,04

**2615** MANIGLIA UOVO  
EGG HANDLE

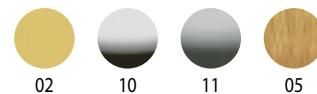

	PEZZI	OLV	OCR	CRSAT	OBGR
CON PLACCA	2	57,51	61,97	61,97	57,51
CON ROSETTA AVVITARE	2	62,78	66,69	66,69	63,72
CON ROSETTA	2	46,44	55,89	55,89	52,52
DK	4	33,21	35,37	35,37	33,62

**2614** MANIGLIONE ALZATA SCORREVOLE  
SLIDING RAISED HANDLE

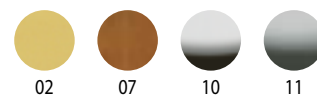

	PEZZI	OLV	CRSAT	PDV
CON PLACCA CON NICCHIA	1	107,33	115,43	162,00
CON PLACCA CON FORO YALE	1	214,65	230,99	324,00

**2615** MANIGLIA FOGLIE  
FOGLIE HANDLE

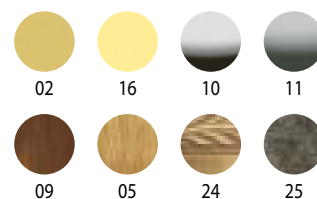

	PEZZI	ORO	ANT	BRIVESTER
CON PLACCA	2	151,88	131,76	127,58
CON ROSETTA AVVITARE	2	151,88	131,76	127,58
DK	4	80,03	72,90	70,87

**1440** MANIGLIA ASTI  
ASTI HANDLE

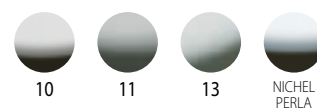

	PEZZI	OCR	CRSAT	NIKISAT	NERO/OP
CON PLACCA	2	52,65	48,60	52,65	48,60
CON ROSETTA QUADRA	2	40,50	36,35	40,50	36,35
CON ROSETTA TONDA Ø 52	2	40,50	36,35	40,50	36,35
DK	4	25,52	23,49	25,52	23,49

**1448** MANIGLIA IDRA  
IDRA HANDLE

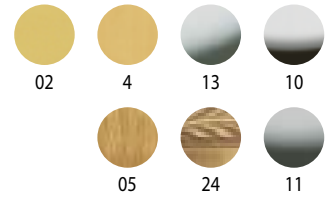

	PEZZI	BRVYESTER	OCR	CRSAT	NIKVSAT
CON PLACCA	2	44,55	44,55	40,50	44,55
CON ROSETTA QUADRA	2	32,54	32,54	28,35	32,54
DK	4	21,47	21,47	19,44	21,47

**2072** MANIGLIA ELLE INOX  
ELLE STAINLESS STEEL HANDLE



INOX

	PEZZI	INOX
BOCC\TONDA	2	18,23
BOCC\OVALE	2	18,36
DK	4	13,37

**2073** MANIGLIA U INOX  
U HANDLE AND STAINLESS STEEL



INOX

	PEZZI	INOX
BOCC\TONDA	2	17,96
BOCC\OVALE	2	18,09
DK	4	13,37

**2074** MANIGLIA NOVANTA INOX  
NOVANTA STAINLESS STEEL HANDLE



INOX

	PEZZI	INOX
BOCC\TONDA	2	18,23
BOCC\OVALE	2	18,36
DK	4	13,37





• **MANIGLIE A INCASSO** •  
*sliding door*



**800** MANIGLIA CORTA PER PORTE SCORREVOLI  
SHORT HANDLE FOR SLIDING DOORS

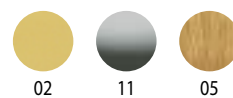

mm	PEZZI	OLV	CRSAT	OBGR
	12	7,43	9,10	8,40

**800 F** MANIGLIA CORTA PER PORTE SCORREVOLI CON FORO CHIAVE  
SHORT HANDLE FOR SLIDING DOORS WITH KEY HOLE

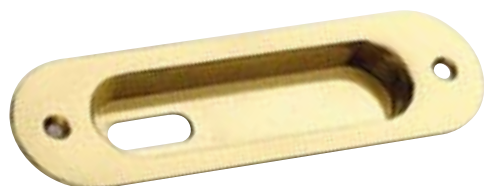

mm	PEZZI	OLV	CRSAT	OBGR
	12	7,43	9,10	8,40

**801** MANIGLIA LUNGA PER PORTE SCORREVOLI  
LONG HANDLE FOR SLIDING DOORS



mm	PEZZI	OLV	CRSAT	OBGR
	12	11,34	14,00	12,46

**801 F** MANIGLIA LUNGA PER PORTE SCORREVOLI CON FORO CHIAVE  
LONG HANDLE FOR SLIDING DOORS WITH KEY HOLE

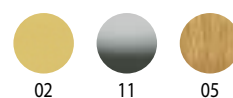

mm	PEZZI	OLV	CRSAT	OBGR
	12	11,34	14,00	12,46

**2002** MANIGLIA A DITALE PER PORTE SCORREVOLI  
FINGER HANDLE FOR SLIDING DOORS



mm	PEZZI	OLV	CRSAT	OBGR
Ø 25X 20	25	3,67	4,20	4,05

**2002 Q** MANIGLIA A DITALE QUADRA PER PORTE SCORREVOLI Ø 25 mm 29X28 mm  
SQUARE FINGER HANDLE FOR SLIDING DOORS d.25mm 29X28 mm

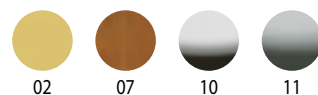

mm	PEZZI	OLV	CRSAT	OBGR
Ø 25mm 29X28 mm	25	3,38	3,38	4,05

**2054** KIT NICCHIA AD INCASSO TONDA CON FORO CHIAVE E DITALE DI TRASCINAMENTO  
ROUND RECESSED NICHE KIT WITH KEY HOLE AND FLUSH FINGER PULL

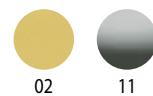

mm	PEZZI	OLV	OCR	CRSAT	OBGR
Ø 57X12mm INT Ø 48mm	1	16,88	19,58	16,88	19,58

**2055** KIT NICCHIA AD INCASSO TONDA CIECA E DITALE DI TRASCINAMENTO  
ROUND RECESSED NICHE KIT BLIND AND FLUSH FINGER PULL

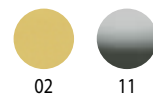

mm	PEZZI	OLV	OCR	CRSAT	OBGR
Ø 57X12mm INT Ø 48mm	1	16,88	19,58	16,88	19,58

**2056** NICCHIA AD INCASSO TONDA CON FORO CHIAVE  
ROUND RECESSED NICHE WITH KEY HOLE

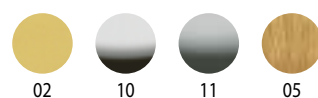

mm	PEZZI	OLV	CRSAT	OBGR
Ø 57X12mm INT Ø 48mm	12	6,08	6,75	6,75

**2057** NICCHIA AD INCASSO TONDA CIECA  
ROUND BLIND RECESSED NICHE

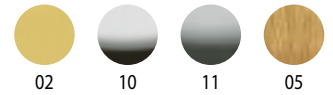

mm	PEZZI	OLV	CRSAT	OBGR
57X44X12	24	6,08	6,75	6,75

**1703** NICCHIA AD INCASSO TONDA CIECA  
ROUND BLIND RECESSED NICHE



mm	PEZZI	OLV	CRSAT	OBGR
Ø 30x12mm INT d.26m	20	4,73	5,40	5,40
Ø 35x12mm INT d.30m	20	5,40	6,08	5,40
Ø 40x12mm INT d.35m	20	5,40	6,08	5,40
Ø 45x12mm INT d.40m	20	5,40	6,75	6,75

**2058** KIT NICCHIA AD INCASSO TONDA CON NOTTOLINO Q.6, SERRATURA ENTRATA mm 50 E DITALE DI TRASCINAMENTO  
ROUND BUILT-IN NICHE KIT LOCKIN PAWL Q.6, ENTRY LOCK 50 mm. AND FLUSH FINGER PULL

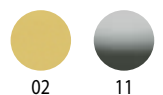
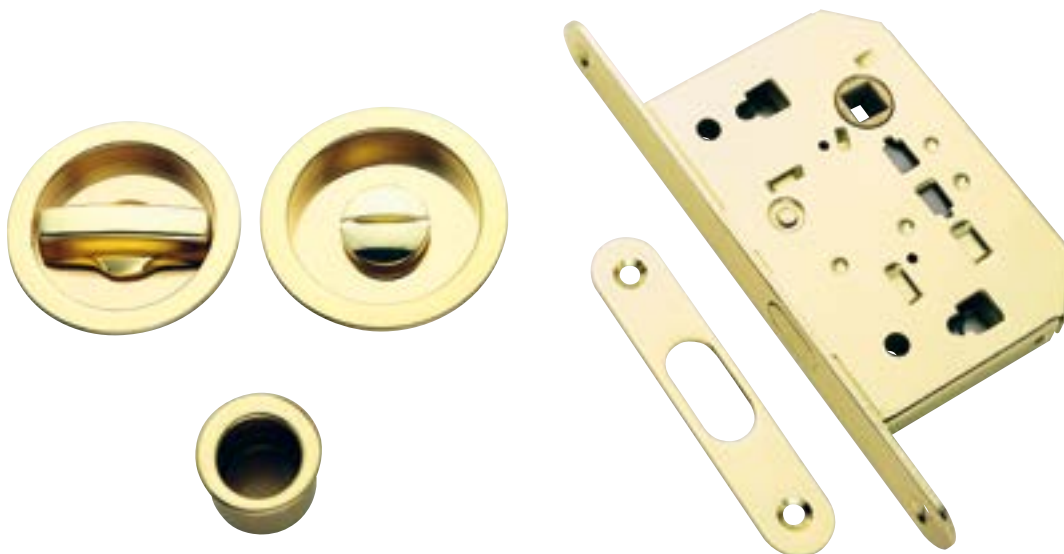

mm	PEZZI	OLV	CRSAT
57X44X12	1	24,96	34,19

**2058 Q** KIT NICCHIA AD INCASSO QUADRA CON NOTTOLINO Q.6, SERRATURA ENTRATA mm 50 E DITALE DI TRASCINAMENTO  
 SQUARE BUILT-IN NICHE KIT WITH RING Q.6, LOCKIN PAWL 50 mm AND FLUSH FINGER PULL



**2058 V** KIT NICCHIA AD INCASSO TONDA CON NOTTOLINO Q.6, SERRATURA ENTRATA mm 50 E DITALE DI TRASCINAMENTO  
 BUILT-IN ROUND NICHE KIT WITH PAWL Q.6 WITH SCREW HOLE, LOCKIN PAWL mm 50 AND FLUSH FINGER PULL



**2059** KIT NICCHIA AD INCASSO TONDA CON FORO CHIAVE Q.6, SERRATURA ENTRATA mm 50 E DITALE DI TRASCINAMENTO  
 ROUND RECESSED NICE KIT WITH KEY HOLE Q.6, ENTRY LOCK 50 mm AND FLUSH FINGER PULL

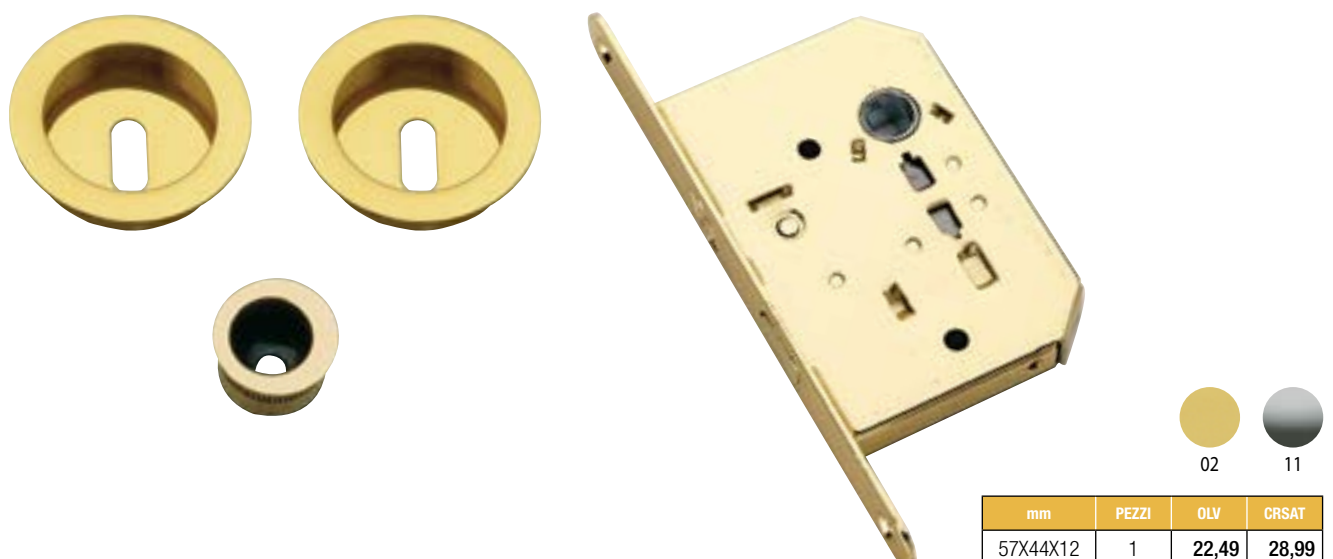

**2059 Q** KIT NICCHIA AD INCASSO QUADRA CON FORO CHIAVE Q.6, SERRATURA ENTRATA mm 50 E DITALE DI TRASCINAMENTO  
 SQUARE RECESSED NICHE KIT WITH KEY HOLE Q.6, INLET LOCK mm 50 AND FLUSH FINGER PULL

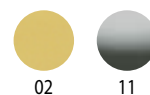

mm	PEZZI	OLV	CRSAT
57X44X12	1	22,49	28,99

**2060** MANIGLIA A DITALE PER PORTE SCORREVOLI  
 THIMBLE HANDLE FOR SLIDING DOORS



mm	PEZZI	OLV	OBV	OCR	CRSAT
29Ø25X 20	50	2,58	2,76	3,06	3,06

**7504** SERRATURA PER PORTE SCORREVOLI CON CHIAVE SNODATA  
 LOCK FOR SLIDING DOORS WITH ARTICULATED KEY

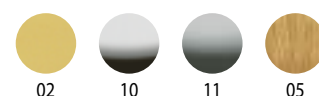
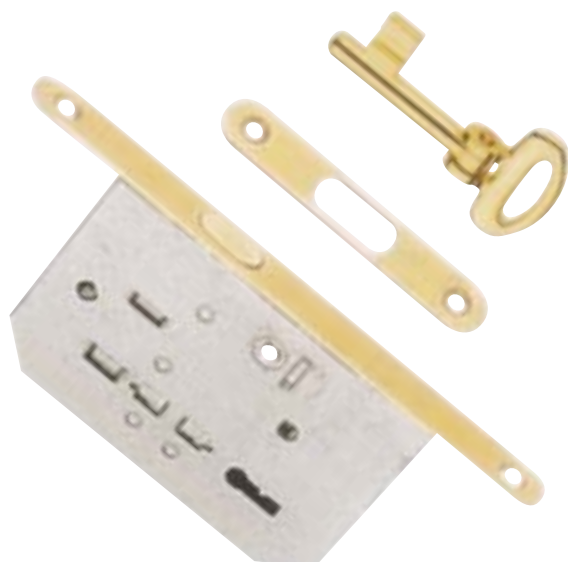

mm	PEZZI	OLV	OCR	CRSAT	OBGR
	2	8,23	8,93	8,93	8,58

**3281** MANIGLIETTA OVALE COPRIVITE CON SOTTOPLASTICA SENZA FORO mm 125X40 INTERNO 80X24 mm  
 OVAL HANDLE WITH SUB-PLASTIC WITHOUT HOLE mm 125X40 INSIDE 80X24

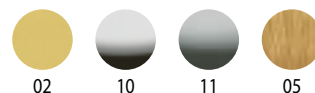

mm	PEZZI	OLV	CRSAT	OBGR
125X40 mm INT 80X24 mm	12	10,88	16,88	10,88

**3282** MANIGLIETTA OVALE COPRIVITE CON SOTTOPLASTICA CON FORO CHIAVE CENTRALE mm 125X40 INTERNO 80X24 mm  
 OVAL HANDLE WITH SUB-PLASTIC WITH CENTRAL KEY HOLE mm 125X40 INSIDE 80X24

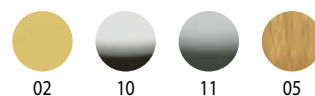

mm	PEZZI	OLV	CRSAT	OBGR
125X40	24	10,88	11,76	10,88

**3276** KIT NICCHIA AD INCASSO OVALE CON NOTTOLINO WC Q. 8  
 OVAL RECESSED NICHE KIT WITH TOILET LOCKIN PAWL Q. 8

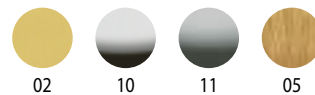
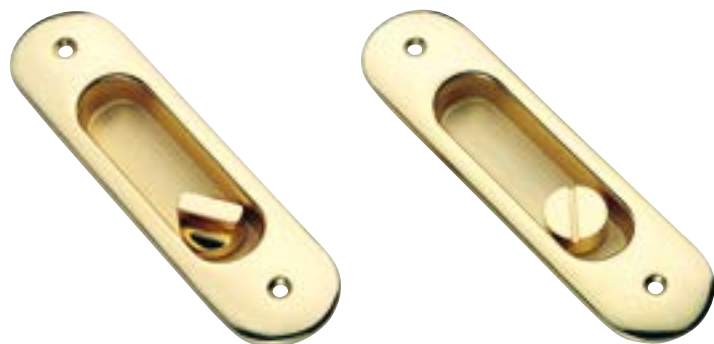

mm	PEZZI	OLV	OCR	CRSAT	OBGR
	1	17,50	21,88	21,88	20,13

**7401** KIT NICCHIA AD INCASSO OVALE CON NOTTOLINO COMPLETA DI SERRATURA E DITALE DI TRASCINAMENTO  
 OVAL BUILT-IN NICHE KIT WITH LATCH COMPLETE WITH LOCKIN PAWL AND FLUSH FINGER PULL

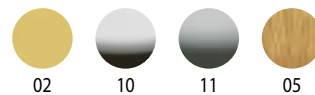
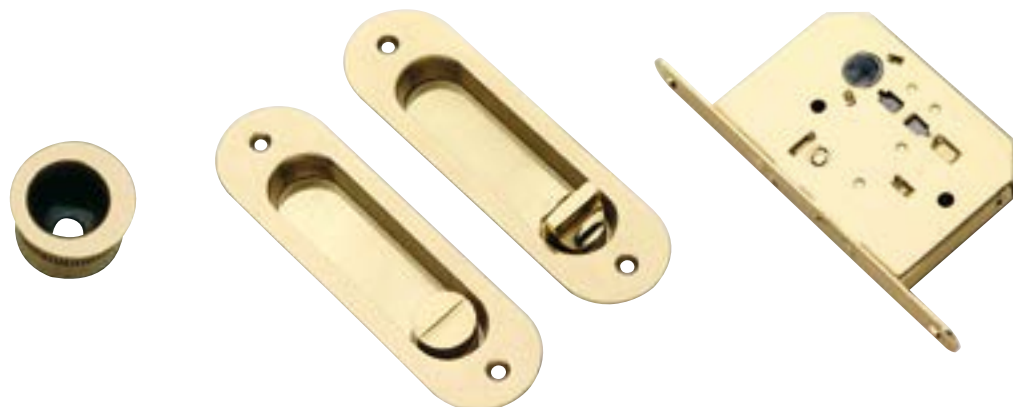

mm	PEZZI	OLV	OCR	CRSAT	OBGR
	1	31,15	40,25	40,25	32,20

**7402** KIT NICCHIA AD INCASSO OVALE CON NOTTOLINO PENDENTE COMPLETA DI SERRATURA E DITALE DI TRASCINAMENTO  
 OVAL RECESSED NICHE KIT WITH PENDANT RING COMPLETE WITH LOCK AND FLUSH FINGER PULL

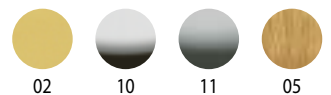

mm	PEZZI	OLV	OCR	CRSAT	OBGR
	1	33,95	42,88	42,88	33,95

**4730** NOTTOLINO PER WC CON POMOLO BASSO  
 LOCKING PAWL FOR WC WITH LOW KNOB

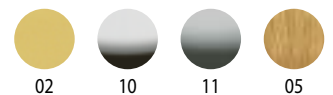

mm	PEZZI	OLV	OCR	CRSAT	OBGR
Ø 45	10	15,48	17,64	17,64	15,48

**4735** NOTTOLINO PER WC CON POMOLO A FARFALLA  
 LOCKING PAWL RATCHET FOR WC WITH BUTTERFLY KNOB

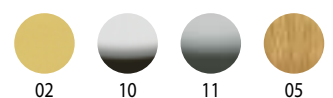

mm	PEZZI	OLV	OCR	CRSAT	OBGR
Ø 45	10	17,08	19,00	19,00	17,08

**4740** NOTTOLINO PER WC CON POMOLO ALTO  
LOCKING PAWL FOR WC WITH HIGH KNOB

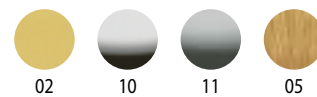

mm	PEZZI	OLV	OCR	CRSAT	OBGR
Ø 45	10	16,27	18,42	18,42	16,27







**POMOLI**  
*knobs*

**77** POMOLO SFERA CON ROSETTA  
BALL KNOB WITH WASHER



mm	PEZZI	OLV	OBGR
Ø 70X70	4	39,60	39,60
Ø 60X70	6	35,75	35,75
Ø 70X70	4	41,80	41,80
Ø 60X70	6	37,95	37,95

CON SOTTOROSONE  
CON SOTTOROSONE

**109** POMOLO GAMMA  
KNOB GAMMA



mm	PEZZI	OLV	OBGR
Ø 70X70	4	19,31	20,46
Ø 60X70	6	18,26	18,81
Ø 60	3	36,74	37,62
Ø 70X70	4	21,18	22,00
Ø 60X70	6	19,91	20,35

ACCOPIATO  
CON SOTTOROSONE  
CON SOTTOROSONE

**110** POMOLO THEMA  
KNOB THEMA



mm	PEZZI	OLV	OBGR
Ø 70X76	4	21,42	22,28
Ø 60X66	6	19,79	20,63
Ø 60	3	39,58	41,25
Ø 70X76	4	22,96	23,82
Ø 60X66	6	21,33	22,17

ACCOPIATO  
CON SOTTOROSONE  
CON SOTTOROSONE

**114** POMOLO SWEDEN  
KNOB SWEDEN

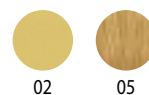

mm	PEZZI	OLV	OBGR
Ø 70X60	4	27,57	27,57
Ø 60X50	6	23,40	23,40
Ø 60	3	43,43	43,43
Ø 70X60	4	24,94	24,94
Ø 60X50	6	21,96	21,96

ACCOPIATO  
CON SOTTOROSONE  
CON SOTTOROSONE

**115** POMOLO DIAMANTE  
KNOB DIAMANTE

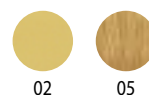

mm	PEZZI	OLV	OBGR
Ø 70X65	4	23,82	26,73
Ø 60X55	6	18,37	19,64
Ø 80X70	2	27,57	28,81
Ø 60	3	40,08	41,35
Ø 70X65	4	25,36	28,27
Ø 60X55	6	19,91	21,18
Ø 80X70	2	29,11	30,35

ACCOPIATO  
CON SOTTOROSONE  
CON SOTTOROSONE  
CON SOTTOROSONE

**340** POMOLO BLINDO  
KNOB BLINDO

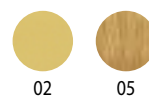

mm	PEZZI	OLV	OBGR
Ø 70	2	17,55	18,90
Ø 70	2	18,90	20,25

CON SOTTOROSONE

**350** POMOLO ELITE'  
KNOB ELITE'



02

05

mm	PEZZI	OLV	CRSAT	OBGR
Ø 70	2	17,55	20,25	18,90
Ø 70	2	18,90	21,60	20,25

CON SOTTOROSONE

**1111** POMOLO IMPERO  
KNOB IMPERO



02

09

05

mm	PEZZI	OLV	ANT	OBGR
Ø 85X65	2	57,87	61,14	61,14
Ø 85X65	2	58,87	62,14	62,14

CON SOTTOROSONE

**2016** POMOLO CIPOLLA  
KNOB CIPOLLA

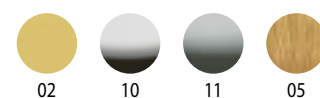

02

10

11

05

mm	PEZZI	OLV	OCR	CRSAT	OBGR
Ø 70	4	12,32	14,19	14,19	12,32

**1704** POMOLO ARES  
KNOB ARES

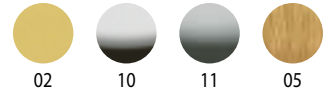

mm	PEZZI	OLV	OCR	CRSAT	OBGR
Ø 65	4	20,25	19,05	19,05	21,60

**1706** POMOLO SPAGNA  
KNOB SPAGNA



mm	PEZZI	OLV	OCR	OBGR
Ø 72	4	17,55	20,25	18,90

**2067** SOTTO ROSONE PER POMOLI  
SUB-ROSE FOR KNOBS



mm	PEZZI
	12
	1,54





**BATTENTI**  
*door knockers*



**73** BATTENTE BAROCCO  
DOOR KNOCKER BAROCCO



mm	PEZZI	OLV	CRSAT	OBGR
120 Ø 150	2	96,64	105,45	96,65
100 Ø 120	2	86,00	84,90	87,10

**74** BATTENTE ESAGONO  
DOOR KNOCKER HEXAGON



mm	PEZZI	OLV	OBGR
90 Ø 120	2	97,90	97,90
80 Ø 100	2	88,22	88,22

**75** BATTENTE ANELLO  
DOOR KNOCKER ANELLO

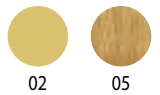

mm	PEZZI	OLV	OBGR
Ø 130	2	77,55	77,55
Ø 110	2	74,04	74,04
Ø 90	2	68,00	68,00

**404** BATTENTE AMERICA  
DOOR KNOCKER AMERICA

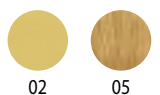

mm	PEZZI	OLV	OBGR
135 Ø 110	2	97,90	97,90

**76** BATTENTE LEONE  
DOOR KNOCKER LION



mm	PEZZI	OLV	OBGR
120X180	2	46,20	46,20
90X130	2	35,20	35,20



**403** BATTENTE LEONE CON ANELLO  
DOOR KNOCKER LION WITH RING



mm	PEZZI	OLV	OBGR
150	2	46,20	46,20
260	1	110,00	110,00

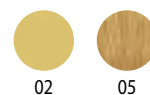

**310** BATTENTE RING  
DOOR KNOCKER RING



mm	PEZZI	OLV	CRSAT	OBGR
Ø 110	2	55,00	64,80	56,10



**320** BATTENTE PORTO  
DOOR KNOCKER PORTO



mm	PEZZI	OLV	OBV	FE-ANT	OBGR
Ø 120	2	63,36	63,36	68,60	63,36



**331** BATTENTE YORK  
DOOR KNOCKER YORK



mm	PEZZI	OLV	OBGR
Ø 110	2	53,90	53,90

**2064** BATTENTE SVEDEN  
DOOR KNOCKER SWEDEN

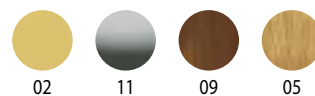

mm	PEZZI	OLV	CRSAT	ANT	OBGR
Ø 110	2	110,00	126,50	110,00	110,00



**ACCESSORI  
PER PORTE E FINESTRE**  
*accessories for doors and windows*

**92** RULLO GUIDA CINGHIA RETTANGOLARE  
RECTANGULAR ROLLER BELT GUIDE

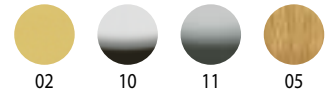

mm	PEZZI	OLV	OBV	OCR	CRSAT	OBGR
60X45X21	24	8,91	9,45	10,80	10,80	9,45

**92 B** RULLO GUIDA CINGHIA OVALE  
OVAL BELT GUIDE ROLLER

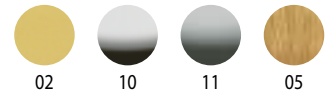

mm	PEZZI	OLV	OBV	OCR	CRSAT	OBGR
60X45X21	24	8,91	9,45	10,80	10,80	9,45

**92 C** RULLO GUIDA CINGHIA TONDO  
ROUND BELT GUIDE ROLLER

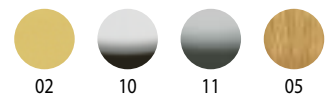

mm	PEZZI	OLV	OBV	OCR	CRSAT	OBGR
60X45X21	24	8,91	9,45	10,80	10,80	9,45

**40** CATENELLA PESANTE  
HEAVY CHAIN

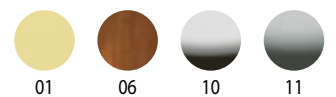

mm	PEZZI	OL	OBV	OCR	CRSAT
180X2	100	3,30	3,52	4,29	5,28

**41** CATENELLA LEGGERA  
LIGHT CHAIN

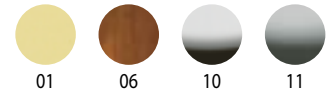

mm	PEZZI	OL	OBV	OCR	CRSAT
150X2	100	2,64	3,30	3,85	4,95

**186** CATENELLA PESANTE INCASSO  
BUILT-IN HEAVY CHAIN



mm	PEZZI	OL	OBV	OCR
240X3	25	12,25	13,81	14,04

**700** CATENELLA  
CHAIN



mm	PEZZI	OLV	OBV	OCR
	25	9,24	10,34	11,00

**701** CATENELLA  
CHAIN



mm	PEZZI	OL
	25	9,24

FINO AD ESAURIMENTO  
OUT OF STOCK

## 27 PINZE PLIERS

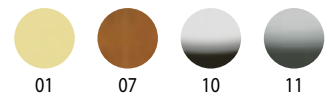

SOLO PINZE  
PINZE/INC A  
PINZE/INC B  
INC A  
INC B

mm	PEZZI	OLV	OBV	OCR	CRSAT
	100	2,16	2,32	2,78	3,40
	50	3,19	3,24	4,12	5,25
	50	3,30	3,35	4,24	5,41
	50	1,03	1,03	1,34	1,85
	50	1,13	1,13	1,44	1,96

## 42 CRICCHETTO A DUE SFERE TWO BALLS RATCHET



mm	PEZZI	OLV	OBV	OCR
8X44	50	1,40	1,50	1,70
9X49	50	1,60	1,80	2,00
11X60	50	1,90	2,10	2,40
13X70	50	2,00	2,30	2,60

## 98 CHIOCCIOLE FERMA PORTE CHIOCCIOLA DOOR STOP

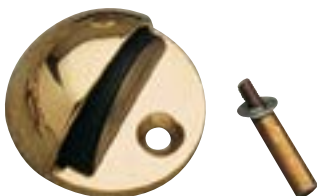

mm	PEZZI	OLV	OBV	OCR
Ø 50	1	3,65	5,76	6,28

## 51 TAVELLINO A SCATTO TAVELLINO SNAP

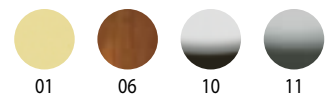

SENZA INCONTRO  
INCONTRO  
INCONTRO  
INCONTRO  
INCONTRO  
INCONTRO  
INCONTRO

mm	PEZZI	OL	OB	OCR	CRSAT
50X35	50	2,21	2,36	2,84	2,37
5	50	0,79	0,95	1,26	1,89
10	50	0,84	1,00	1,31	1,94
15	50	0,89	1,05	1,37	2,00
20	50	0,95	1,10	1,42	2,05
25	50	1,00	1,16	1,47	2,10
30	50	1,05	1,21	1,52	2,15

**2096** TAVELLINO ALLA ROMANA CON INCONTRO E MOLLA  
 ROMAN TAVELLINO WITH BUILT-IN KEEPER AND SPRING

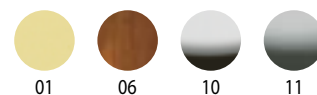

mm	PEZZI	OL	OB	OCR	CRSAT
5	25	4,29	4,62	5,28	5,94
10	25	4,40	4,73	5,39	6,05
15	25	4,51	4,84	5,50	6,16
18	25	4,62	4,95	5,61	6,27
20	25	4,73	5,06	5,72	6,38
22	25	4,84	5,17	5,83	6,49
25	25	4,95	5,28	5,94	6,60
30	25	5,06	5,39	6,05	6,71

**288** TAVELLINO REGOLABILE  
 ADJUSTABLE TAVELLINO

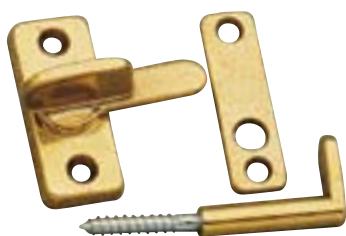

mm	PEZZI	OL	OB	OCR	OCR
	50	6,00	6,47	6,80	6,85

**2089** TAVELLINO TONDO A SCATTO DX-SX  
 ROUND TAVELLINO RIGHT-LEFT

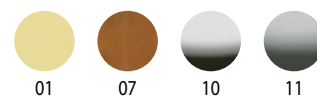

mm	PEZZI	OL	OB	OCR	CRSAT
	5	6,27	6,60	7,59	8,91

**2083** CHIAVISTELLO PER WC  
 LOCK FOR WC

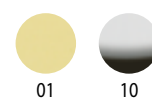

mm	PEZZI	OL	OCR
	5	34,73	40,92



**34** CRICCHETTO SOPRALUCE  
RATCHET OVER LIGHT

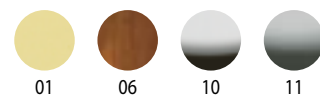
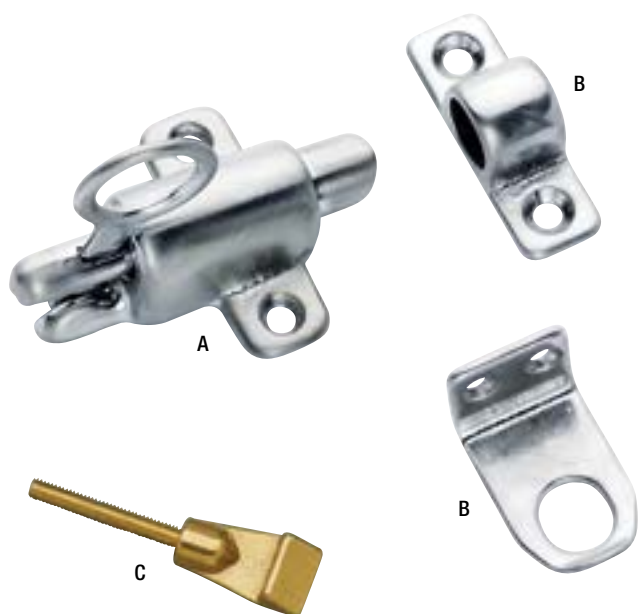

CON INCONTRO A  
CON INCONTRO B  
SENZA INCONTRO  
INCONTRO A  
INCONTRO B  
INCONTRO C

mm	PEZZI	OL	OB	OCR	CRSAT
60X45X45	50	3,25	3,60	4,20	5,40
60X45X45	50	3,95	3,70	4,30	5,50
	50	2,40	2,70	3,00	3,60
	50	0,75	0,90	1,20	1,80
	50	0,85	1,00	1,30	1,90
	100	2,85	3,00	4,20	5,40

**71** OMINO FERMA PERSIANE  
LITTLE MAN STOP SHUTTERS

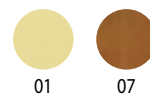
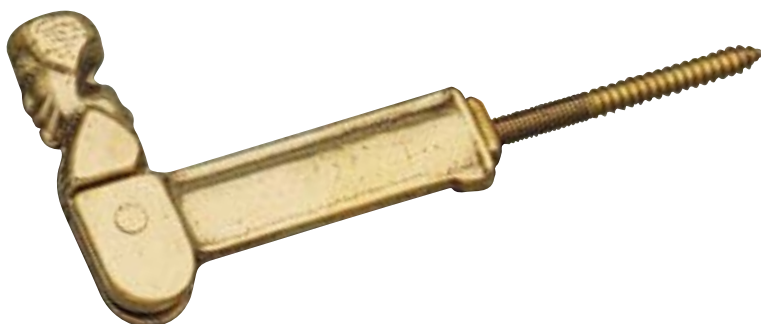

A ZANCA  
A VITE

mm	PEZZI	OL	OBV
	20	7,12	8,03
	20	7,12	8,03

**71 B** OMINO FERMA PERSIANE CON FERMO  
LITTLE MAN STOP SHUTTERS WITH STOP

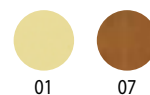
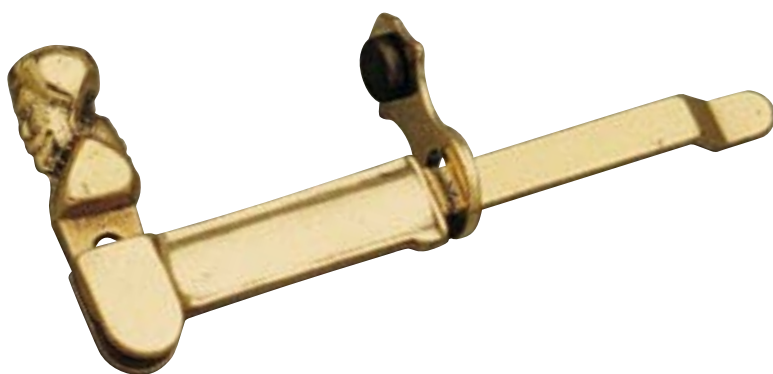

A ZANCA  
A VITE

mm	PEZZI	OL	OBV
	20	7,12	8,03
	20	7,12	8,03

**450** FERMA PERSIANE GOCCIA CON FERMO REGOLABILE  
*DROP SHUTTER STOP WITH ADJUSTABLE STOP*



mm	PEZZI	OLV	OBV	ANT
65	20	13,92	15,03	16,34

**451** FERMA PERSIANE GOCCIA CON FERMO  
*STOP SHUTTERS DROP WITH STOP*



mm	PEZZI	OLV	OBV	ANT
55	20	10,70	11,76	13,77

**999** OMINO FERMA PERSIANE REGOLABILE  
*LITTLE MAN STOP SHUTTERS WITH ADJUSTABLE STOP*

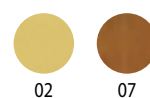
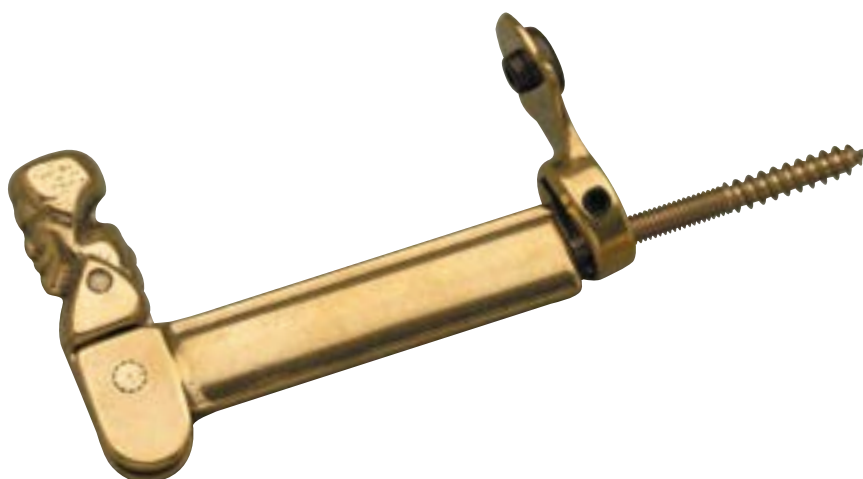

mm	PEZZI	OLV	OBV
	20	13,13	15,07

**455** GANCIO REGOLABILE FERMA PERSIANE REG 5 cm.  
ADJUSTABLE HOOK SHUTTER STOP 5 cm.



mm	PEZZI	OLV	OBV	ANT
200	15	21,84	22,66	23,76
250	15	22,28	23,17	24,75
300	15	22,72	23,61	25,52

**277** GANCIO FERMA PERSIANE DOPPIO SNODO  
DOUBLE JOINTED SHUTTER STOP HOOK



mm	PEZZI	OL	OB	OCR
50	50	7,90	9,13	10,31
75	50	9,04	10,15	11,44
100	50	9,49	10,69	11,87
125	50	10,09	11,20	12,44
150	50	10,86	12,06	13,22
165	50	13,17	13,40	14,85
185	50	12,49	13,84	15,10
200	25	12,68	13,92	15,39
250	25	14,52	15,92	17,17
300	25	15,82	17,17	18,46

**53** GANCIO FERMA PERSIANE  
SHUTTER STOP HOOK

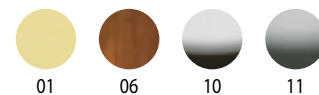

mm	PEZZI	OL	OB	OCR	CRSAT
60	50	3,40	3,65	4,54	4,98
80	50	3,68	3,89	4,73	5,25
100	50	3,99	4,20	4,94	5,51
120	50	4,20	4,41	5,15	5,99
140	50	4,41	4,62	5,36	6,20
160	50	6,14	6,83	7,10	7,88
180	50	6,29	7,35	7,69	8,40
200	25	7,53	7,94	8,37	8,93
250	25	8,78	9,19	9,37	10,08
300	25	10,30	10,50	11,03	11,55

**460** FERMA PERSIANE CON INCONTRO  
SHUTTER STOP WITH MEETING

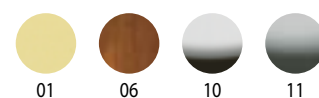

mm	PEZZI	OL	OB	OCR	ANT
85X25	30	10,42	11,11	12,89	11,77

**461** FERMA PERSIANE CON GANCIO A MOLLA INOX  
SHUTTERS WITH STAINLESS STEEL SPRING HOOK



mm	PEZZI	OL	OB	OCR	ANT
85X25	30	10,42	11,11	12,89	11,77

**137** SPAGNOLETTA  
ESPAGNOLETTE

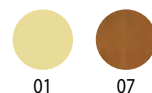

mm	PEZZI	OL	OBV	OCR	CRSAT
60 INC 5	50	6,41	6,89	9,38	10,95
60 INC 25	50	6,41	6,89	9,38	10,95
60 INC 30	50	6,41	6,89	9,38	10,95
80 INC 5	50	6,83	7,32	9,98	11,63
80 INC 25	50	6,83	7,32	9,98	11,63
80 INC 30	50	6,83	7,32	9,98	11,63

**36** MANIGLIA A BLOCCO LEGGERA DX-SX  
RIGHT-LEFT LIGHT BLOCK HANDLE

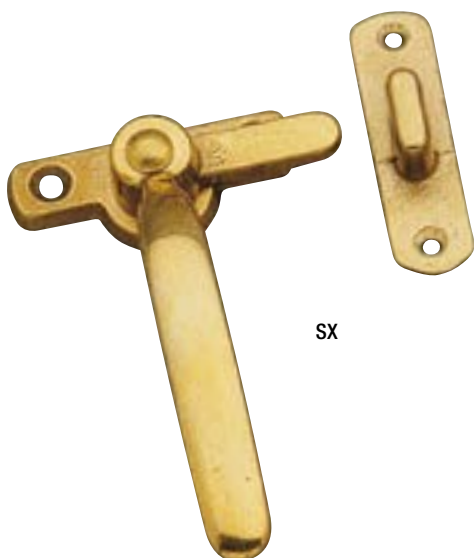

mm	PEZZI	OL	OBV	OCR	CRSAT
	12	5,36	5,67	6,62	7,88

**37** MANIGLIA A BLOCCO PESANTE DX-SX  
RIGHT-LEFT HEAVY BLOCK HANDLE

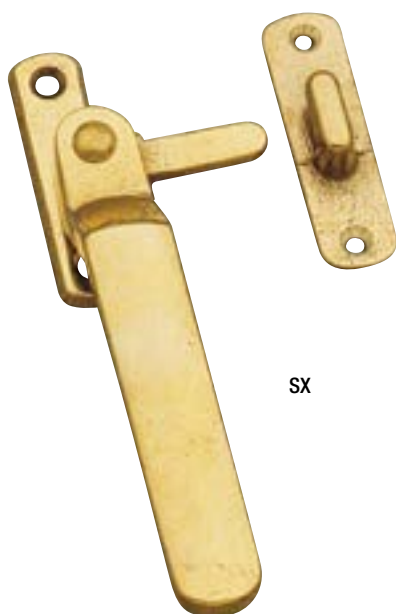

mm	PEZZI	OL	OBV	OCR	CRSAT
	12	5,36	5,67	6,62	7,88

**87** GIREVOLI PER PERSIANE  
SWIVEL FOR SHUTTERS

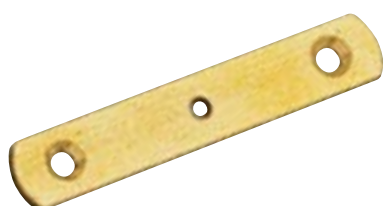

	mm	PEZZI	OL
DISTANZA 52	12X2X60	100	0,53
DISTANZA 54	12X2X60	100	0,58

**70** GUIDA VASISTAS  
VASISTAS GUIDE

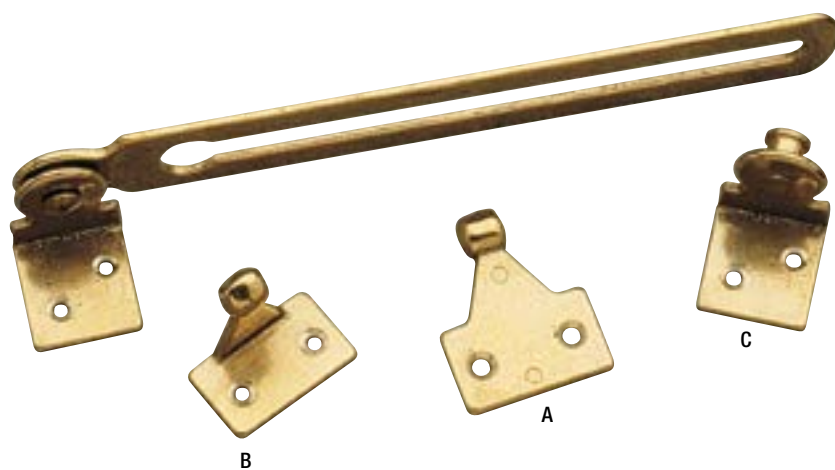

	mm	PEZZI	OL	OBV	OCR
A	200X25X35	25	5,89	6,47	6,96
B	200X25X35	25	5,89	6,47	6,96
C	200X25X35	25	6,01	6,60	7,20

**38** GANCIO DI SICUREZZA TIPO ROMA  
ROMA TYPE SAFETY HOOK



mm	PEZZI	OL	OBV	OCR	CRSAT
130X65	12	6,04	6,44	7,48	8,63

**35** CAVALLOTTO A RULLO  
ROLLER HOLDERS

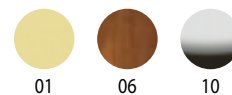

mm	PEZZI	OL	OBV	OCR
11	100	1,52	1,70	1,88
15	100	1,52	1,70	1,88
18	100	1,52	1,70	1,88
20	100	1,52	1,70	1,88
22	100	1,63	1,81	1,98
25	100	1,63	1,81	1,98
30	100	1,63	1,81	1,98

**2019** CHIDO A PIRAMIDE  
PYRAMID NAIL

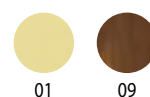

mm	PEZZI	OL	ANT
20X20	24	3,60	4,20

**2019 B** CHIDO A PIRAMIDE CON FORO FILETTATO PER VITE  
PYRAMID NAIL WITH THREADED HOLE FOR SCREW

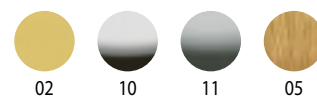
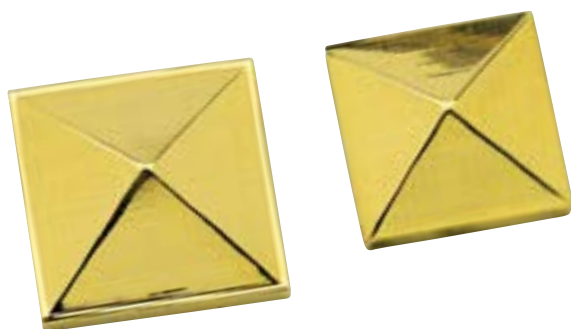

mm	PEZZI	OL	OCR	CRSAT	OBGR
25X25	20	3,77	4,95	5,10	3,90
30X30	20	4,34	5,70	5,80	4,49
35X35	20	5,78	7,20	7,30	6,00

**2019 C** CHIDO A PIRAMIDE CON FORO FILETTATO PER VITE  
*PYRAMID NAIL WITH THREADED HOLE FOR SCREW*

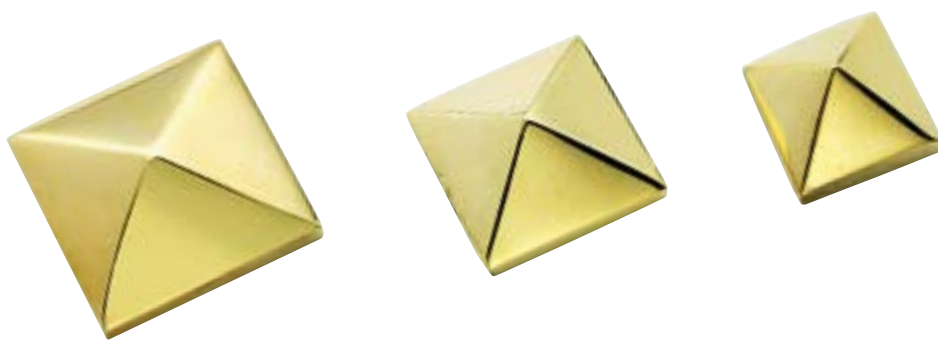

mm	PEZZI	OL	ANT
20X20	20	2,70	2,70
25X25	20	3,78	3,78
30X30	20	4,32	4,32



**POMOLINI E  
MANIGLIETTE**

*furniture knobs and handles*



**82** POMOLINO OTTAGONALE IN OTTONE  
OCTAGONAL BRASS KNOB



mm	PEZZI	OLV	OCR	CRSAT	OBGR	BR-YESTER
25	50	4,08	4,71	4,84	4,92	4,92
30	30	4,62	5,41	5,55	5,46	5,46
38	30	6,29	7,00	7,13	7,16	7,16
45	30	8,54	9,41	9,55	9,54	9,54

**83** POMOLINO LISCIO IN OTTONE  
SMOOTH BRASS KNOB



mm	PEZZI	OLV	OBV	OCR	CRSAT	OBGR
22	50	2,51	3,01	2,97	3,16	3,28
28	50	3,28	3,78	3,74	3,90	3,93
34	30	4,71	5,25	5,25	5,36	5,48
40	30	6,25	6,75	6,87	7,04	7,14

**94** POMOLINO SFERA SENZA BASE IN OTTONE  
BALL KNOB WITHOUT BRASS BASE

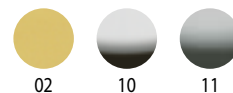

mm	PEZZI	OLV	OCR	CRSAT
15	50	1,77	2,20	2,31
20	50	2,35	2,82	2,93
25	50	3,36	3,82	4,01
30	30	5,05	5,63	5,74
35	20	7,21	7,91	8,02

**108** POMOLINO SFERA CON BASE IN OTTONE  
BALL KNOB WITH BRASS BASE

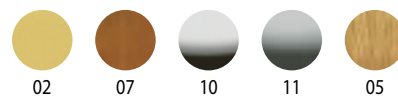

mm	PEZZI	OLV	OBV	OCR	CRSAT	OBGR
18	50	2,35	2,85	2,78	2,97	3,09
22	50	3,28	3,51	3,47	3,63	3,78
26	30	4,01	4,44	4,55	4,74	4,71
30	30	5,71	6,17	6,25	6,48	6,44

**201** POMOLINO IN OTTONE  
BRASS KNOB



mm	PEZZI	OLV	OBV	OCR	CRSAT	OBGR
20	50	1,97	2,39	2,39	2,58	2,70
25	30	3,01	3,47	3,51	3,66	3,78
30	30	4,47	5,05	5,01	5,17	5,25
35	30	5,63	6,25	6,21	6,36	6,48

**202** POMOLINO IN OTTONE  
BRASS KNOB



mm	PEZZI	OLV	OBV	OCR	CRSAT	OBGR
15	50	1,89	2,31	2,31	2,43	2,55
20	50	2,43	2,97	2,85	3,05	3,16
25	50	3,74	4,17	4,24	4,44	4,55
30	30	5,63	6,13	6,21	6,36	6,48
35	20	7,87	8,56	8,52	8,64	8,72

**203** POMOLINO IN OTTONE  
BRASS KNOB

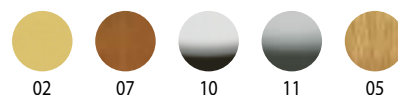

mm	PEZZI	OLV	OBV	OCR	CRSAT	OBGR
20	50	2,20	2,62	2,74	2,82	2,85
25	30	3,16	3,63	3,66	3,78	3,82
30	30	4,40	4,82	5,05	5,17	5,17
35	30	6,25	6,87	6,87	7,10	7,02

**204** POMOLINO IN OTTONE  
BRASS KNOB



mm	PEZZI	OLV	OBV	OCR	CRSAT	OBGR
20	50	2,39	2,89	2,82	2,82	3,05
25	30	3,24	3,74	3,74	3,78	3,97
30	30	4,71	5,17	5,21	5,17	5,52
35	30	6,06	6,67	6,67	7,10	6,87

**205** POMOLINO IN OTTONE  
BRASS KNOB



mm	PEZZI	OLV	OBV	OCR	CRSAT	OBGR
17	50	1,89	2,31	2,24	2,82	2,51
20	50	2,20	2,66	3,74	3,78	2,89
25	50	2,78	3,32	5,21	5,17	3,51
32	30	4,13	4,71	6,67	7,10	4,82

**206** POMOLINO IN OTTONE  
BRASS KNOB

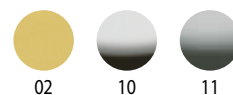

mm	PEZZI	OLV	OBV	OCR	CRSAT
12	50	1,85	2,24	2,24	2,35

**207** POMOLINO IN OTTONE  
BRASS KNOB

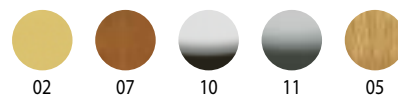

mm	PEZZI	OLV	OBV	OCR	CRSAT	OBGR
17	50	2,09	2,35	2,35	2,47	2,58
20	50	2,43	2,93	2,85	2,97	3,09
25	50	3,09	3,63	3,59	3,66	3,82
32	30	4,51	5,09	5,05	5,21	5,25

**208** POMOLINO IN OTTONE  
BRASS KNOB



mm	PEZZI	OLV	OBV	OCR	CRSAT	OBGR
16	50	2,35	1,89	1,89	2,07	2,07
20	50	3,01	2,27	2,27	2,46	2,46
25	50	2,71	3,05	3,05	3,23	3,23
30	30	4,21	4,21	4,21	4,34	4,34

**210** POMOLINO IN OTTONE  
BRASS KNOB

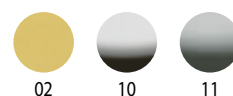

mm	PEZZI	OLV	OCR	CRSAT
24	50	2,93	3,39	3,61

**768** POMOLINO IN OTTONE  
BRASS KNOB

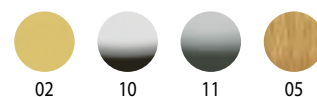

mm	PEZZI	OLV	OCR	CRSAT	OBGR
20	50	2,35	2,43	2,61	3,05
25	50	2,89	3,28	4,67	3,63
30	30	4,24	4,67	4,94	5,09

**755** POMOLINO IN OTTONE  
BRASS KNOB

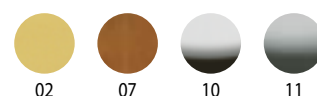

mm	PEZZI	OLV	OBV	OCR	CRSAT
17	50	1,97	2,20	2,43	2,51

**735** POMOLINO IN OTTONE  
BRASS KNOB

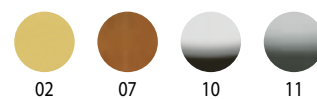

mm	PEZZI	OLV	OBV	OCR	CRSAT
16	50	2,08	2,58	2,55	2,59
20	50	2,66	3,20	3,16	3,28
25	50	4,09	4,71	4,74	4,67

**740** POMOLINO IN OTTONE  
BRASS KNOB

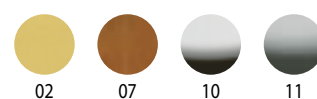

mm	PEZZI	OLV	OBV	OCR	CRSAT
14	50	1,97	2,31	2,39	2,51
18	50	2,39	2,74	2,85	2,97
22	50	3,24	3,59	3,74	3,86

**750** POMOLINO IN OTTONE  
BRASS KNOB



mm	PEZZI	OLV	OBV	OCR	CRSAT	OBGR
18	50	2,24	1,85	2,70	2,82	2,97

**770** POMOLINO IN OTTONE  
BRASS KNOB



mm	PEZZI	OLV	OBGR
25	50	4,58	5,41
32	50	6,12	7,00

**2034** POMOLINO TONDO IN PORCELLANA BIANCA  
*ROUND KNOB IN WHITE PORCELAIN*



mm	PEZZI	
Ø 26 X24	25	2,77
Ø 30 X25	25	2,77

**2036** POMOLINO TONDO IN PORCELLANA CHAMPAGNE  
*ROUND KNOB IN CHAMPAGNE PORCELAIN*



mm	PEZZI	
Ø 26 X24	25	2,77
Ø 30 X25	25	2,77

**2038** POMOLINO TONDO IN PORCELLANA BIANCA CON FIORE BLU  
*ROUND KNOB IN WHITE PORCELAIN WITH BLUE FLOWER*



mm	PEZZI	
Ø 30 X25	25	3,28

**2045** POMOLINO TONDO IN PORCELLANA BIANCA CON FIORE  
*ROUND KNOB IN WHITE PORCELAIN WITH FLOWER*



mm	PEZZI	
Ø 30 X25	25	3,28

**2040** POMOLINO TONDO IN PORCELLANA BIANCA CON FIORE ROSSO  
*ROUND KNOB IN WHITE PORCELAIN WITH RED FLOWER*



mm	PEZZI	
Ø 30 X25	25	3,28

**2035** POMOLINO OVALE IN PORCELLANA BIANCA  
OVAL KNOB IN WHITE PORCELAIN



mm	PEZZI	
Ø 30 X24	25	3,39

**2037** POMOLINO OVALE IN PORCELLANA CHAMPAGNE  
OVAL KNOB IN CHAMPAGNE PORCELAIN



mm	PEZZI	
Ø 30 X24	25	3,39

**2046** POMOLINO OVALE IN PORCELLANA BIANCA CON MARGHERITA  
OVAL KNOB IN WHITE PORCELAIN WITH DAISY



mm	PEZZI	
Ø 30 X24	25	3,77

**2042** POMOLINO OVALE IN PORCELLANA BIANCA CON FIORELLINI BLU  
OVAL KNOB IN WHITE PORCELAIN WITH BLUE SMALL FLOWERS.



mm	PEZZI	
Ø 30 X24	25	3,77

**2043** POMOLINO TONDO IN PORCELLANA BIANCA CON FIORE MARRONE  
ROUND KNOB IN WHITE PORCELAIN WITH BROWN FLOWER



mm	PEZZI	
Ø 26 X24	25	3,39
Ø 30 X25	25	3,39

**2044** POMOLINO TONDO IN PORCELLANA CHAMPAGNE CON IBISCO  
*CHAMPAGNE ROUND PORCELAIN KNOB WITH HIBISCUS*



mm	PEZZI	
Ø 26 X24	25	<b>3,39</b>
Ø 30 X25	25	<b>3,39</b>

**2041** POMOLINO OVALE IN PORCELLANA CHAMPAGNE CON FIORE ROSSO  
*OVAL CHAMPAGNE PORCELAIN KNOB WITH RED FLOWER*



mm	PEZZI	
Ø 30 X24	25	<b>3,77</b>

**2039** POMOLINO OVALE IN PORCELLANA BIANCA CON FIORE BLU  
*OVAL KNOB IN WHITE PORCELAIN WITH BLUE FLOWER*



mm	PEZZI	
Ø 30 X24	25	<b>3,77</b>

**2052** BASE PER POMOLINI IN PORCELLANA  
*PORCELAIN KNOB BASE*



mm	PEZZI	OL	OCR	BR-ANT
	25	<b>0,68</b>	<b>0,81</b>	<b>0,81</b>

**2034 B** MANIGLIETTA EXTRA IN PORCELLANA BIANCA INTERASSE mm 74  
*EXTRA HANDLE IN WHITE PORCELAIN INTERAXIS mm 74*



mm	PEZZI	ANT
74	25	<b>6,58</b>

**3260 B** MANIGLIETTA EXTRA IN PORCELLANA BIANCA CON MELA VERDE INTERASSE mm 74  
 EXTRA HANDLE IN WHITE PORCELAIN WITH GREEN APPLE INTERAXIS mm 74



mm	PEZZI	ANT
74	25	7,32

**2041 B** MANIGLIETTA EXTRA IN PORCELLANA CHAMPAGNE CON FIORE ROSSO INTERASSE mm 74  
 EXTRA PORCELAIN HANDLE CHAMPAGNE WITH RED FLOWER INTERAXIS mm 74



mm	PEZZI	ANT
74	25	7,32

**2038 B** MANIGLIETTA EXTRA IN PORCELLANA BIANCA CON FIORE BLU INTERASSE mm 74  
 EXTRA HANDLE IN WHITE PORCELAIN WITH BLUE FLOWER INTERAXIS mm 74



mm	PEZZI	ANT
74	25	7,32

**2043 B** MANIGLIETTA EXTRA IN PORCELLANA BIANCA CON FIORE MARRONE INTERASSE mm 74  
 EXTRA HANDLE IN WHITE PORCELAIN WITH BROWN FLOWER INTERAXIS mm 74



mm	PEZZI	ANT
74	25	7,32

**2046 B** MANIGLIETTA EXTRA IN PORCELLANA BIANCA CON MARGHERITA INTERASSE mm 74  
 EXTRA HANDLE IN WHITE PORCELAIN WITH DAISY INTERAXIS mm 74



mm	PEZZI	ANT
74	25	7,32

**2036 B** MANIGLIETTA EXTRA IN PORCELLANA CHAMPAGNE INTERASSE mm 74  
 EXTRA PORCELAIN HANDLE CHAMPAGNE INTERAXIS mm 74



mm	PEZZI	ANT
74	25	7,32



**2023** MANIGLIETTA PENDENTE AD ANELLO IN OTTONE  
RING PENDANT HANDLE

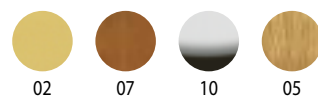

mm	PEZZI	OLV	OBV	OCR
∅ 32	25	2,70	3,11	3,11

**3261** MANIGLIETTA RIALTO IN OTTONE  
RIALTO BRASS HANDLE

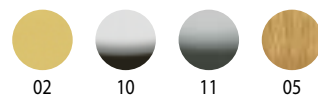

mm	PEZZI	OLV	OCR	CRSAT	OBGR
64	25	2,93	3,86	3,86	3,51
96	25	4,62	5,85	5,85	5,13

**2029** MANIGLIETTA A INCASSO QUADRATA  
BUILT-INSQUARE HANDLE IN BRASS

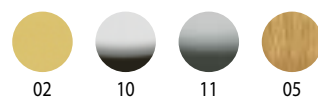

mm	PEZZI	OLV	OCR	CRSAT	OBGR
40X55	25	5,92	8,82	8,82	5,92

**43** MANETTINA PER MOBILI IN OTTONE  
HANDLE FOR BRASS FURNITURE

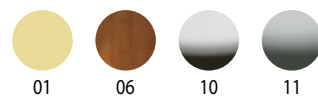

mm	PEZZI	OL	OB	OCR	CRSAT
80	50	1,22	1,51	1,69	1,89
100	50	1,37	1,69	1,81	2,05
120	50	1,51	1,81	1,98	2,21
140	50	1,69	1,65	2,17	2,36

**44** MANETTINA SCANALATA IN OTTONE  
HANDLE FOR FURNITURE GROOVED IN BRASS

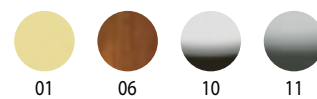

mm	PEZZI	OL	OB	OCR	CRSAT
140	30	3,78	4,08	4,38	4,98

**45** MANETTINA RIGATA IN OTTONE  
HANDLE FOR BRASS STRIPED FURNITURE

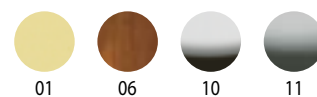

mm	PEZZI	OL	OB	OCR	CRSAT
140	30	3,78	4,08	4,38	4,98





**SUPPORTI CORRIMANO ACCESSORI  
PER RINGHIERE**  
*supports handrail accessories for railings*

**54** SUPPORTO CORRIMANO  
PLAIN SUPPORT FOR HANDRAIL



mm	PEZZI	OLV	OBV	OCR	CRSAT	OBGR
60X62X40	12	10,53	11,07	11,61	11,61	11,07

**54 B** SUPPORTO CORRIMANO TESTA CONCAVA  
CONCAVE SUPPORT FOR HANDRAIL



mm	PEZZI	OLV	OBV	OCR	CRSAT	OBGR
65X66X53	12	10,53	11,07	11,61	11,61	11,07

**54 C** SUPPORTO CORRIMANO TESTA PIANA  
PLAIN SUPPORT FOR HANDRAIL

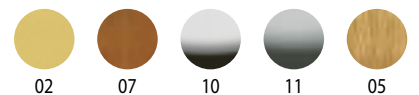

mm	PEZZI	OLV	OBV	OCR	CRSAT	OBGR
65X66X56	12	10,53	11,07	11,61	11,61	11,07

**54 D** SUPPORTO CORRIMANO TESTA CONCAVA  
CONCAVE SUPPORT FOR HANDRAIL

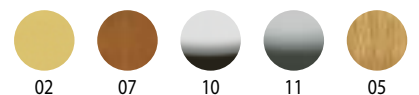

mm	PEZZI	OLV	OCR	CRSAT	OBGR
80X63X70	12	12,69	14,18	14,18	13,50

**54 E** SUPPORTO CORRIMANO TESTA PIANA  
PLAIN SUPPORT FOR HANDRAIL

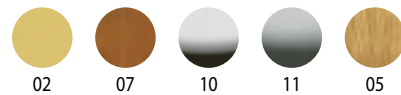

mm	PEZZI	OLV	OCR	CRSAT	OBGR
80X63X70	12	12,69	14,18	14,18	13,50

**54 F** SUPPORTO CORRIMANO CON VITI A VISTA  
HANDRAIL SUPPORT WITH VISIBLE SCREWS



mm	PEZZI	OLV	OBV	OCR	CRSAT	OBGR
	12	9,31	9,31	12,53	12,53	9,31

**54 H** SUPPORTO CORRIMANO CON TESTA PIANA SLIM  
HANDRAIL SUPPORT WITH SLIM FLAT HEAD



mm	PEZZI	OLV	OBV	OCR	CRSAT	OBGR
	12	8,82	8,82	11,76	11,76	8,82

**2008** SUPPORTO CORRIMANO ZANCATO LISCIO  
SMOOTH CLAMPED HANDRAIL SUPPORT

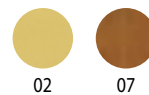

mm	PEZZI	OLV	OBV
Ø 30	6	17,75	17,75
Ø 35	6	18,86	18,86

**2008 B** SUPPORTO CORRIMANO ZANCATO RIGATO  
STRIPED CLAMPED HANDRAIL SUPPORT

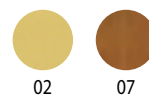

mm	PEZZI	OLV	OBV
Ø 30	6	18,86	18,86
Ø 35	6	20,52	20,52

**2008 C** SUPPORTO CORRIMANO LISCIO  
SMOOTH HANDRAIL SUPPORT



mm	PEZZI	OLV	OBV
Ø 30	6	17,75	17,75
Ø 35	6	18,86	18,86

**2008 D** SUPPORTO CORRIMANO RIGATO  
STRIPED HANDRAIL SUPPORT

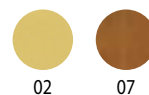

mm	PEZZI	OLV	OBV
Ø 30	6	18,86	18,86
Ø 35	6	20,52	20,52

**2009 B** FINALE PER CORRIMANO A PALLA  
FINAL FOR BALL HANDRAIL

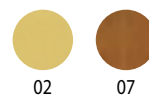

mm	PEZZI	OLV	OBV
Ø 30	6	18,73	18,73
Ø 35	6	21,63	21,63

**175** SUPPORTI NODO SEMPLICE  
SIMPLE KNOT SUPPORT

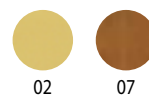

mm	PEZZI	OLV	OBV
Ø 30 FORO 12	6	7,48	7,48
Ø 30 FORO 14	6	7,48	7,48
Ø 35 FORO 16	6	8,18	8,18
Ø 35 FORO 18	6	8,18	8,18

\* CON FORO FILETTATO E VITE AGGIUNGERE € 1,30 CAD.  
WITH THREADED HOLE AND SCREW ADD € 1.30 CAD.

**175 T** TERMINALI SUPPORTI NODO SEMPLICE  
SIMPLE NODE SUPPORT TERMINAL

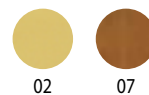

mm	PEZZI	OLV	OBV
Ø 30 FORO 12	6	3,99	3,99
Ø 30 FORO 14	6	3,99	3,99
Ø 35 FORO 16	6	3,99	3,99
Ø 35 FORO 18	6	3,99	3,99

\* CON FORO FILETTATO E VITE AGGIUNGERE € 1,30 CAD.  
WITH THREADED HOLE AND SCREW ADD € 1.30 CAD.

**175 B** SUPPORTI DOPPIO NODO  
DOUBLE KNOT SUPPORT



mm	PEZZI	OLV	OBV
Ø 30 FORO 12	6	7,48	7,48
Ø 30 FORO 14	6	7,48	7,48
Ø 35 FORO 16	6	8,18	8,18
Ø 35 FORO 18	6	8,18	8,18

\* CON FORO FILETTATO E VITE AGGIUNGERE € 1,30 CAD.  
WITH THREADED HOLE AND SCREW ADD € 1.30 CAD.



## 175 C SUPPORTI NODO LISCIO SMOOTH KNOT SUPPORT

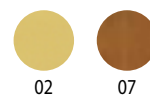

mm	PEZZI	OLV	OBV
Ø 30 FORO 12	6	7,48	7,48
Ø 30 FORO 14	6	7,48	7,48
Ø 35 FORO 16	6	8,18	8,18
Ø 35 FORO 18	6	8,18	8,18

\* CON FORO FILETTATO E VITE AGGIUNGERE € 1,30 CAD.  
WITH THREADED HOLE AND SCREW ADD € 1.30 CAD.



**COPRI INTERRUTTORI, CAMPANELLI,  
BUCHE PER LETTERE, TARGHE**  
*switch covers, door bells, letter plates, plates*

**500** BUCA PER LETTERE APERTURA ESTERNA  
OUTDOOR OPENING LETTER HOLE

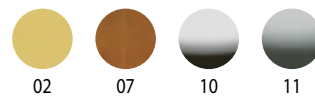

mm	PEZZI	OLV	OBGR	OCR	CRSAT
254x75	1	30,31	30,31	42,44	42,44

**501** BUCA PER LETTERE APERTURA INTERNA  
INTERNAL OPENING LETTERS HOLE

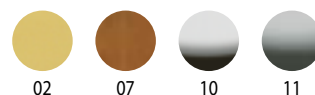
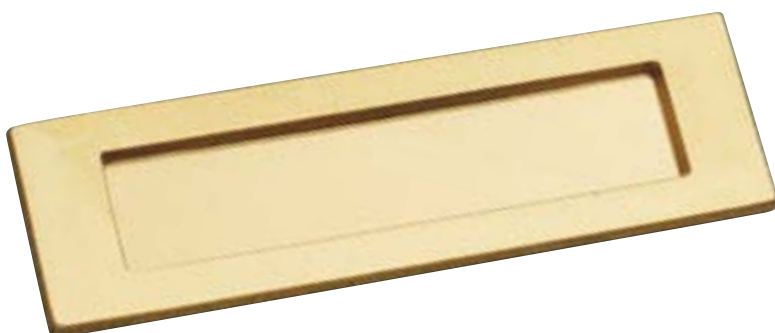

mm	PEZZI	OLV	OBGR	OCR	CRSAT
254x75	1	24,30	28,35	32,40	32,40

**67** COPRI INTERRUPTORI RETTANGOLARE  
RECTANGULAR SWITCH COVER

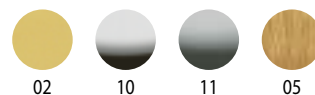
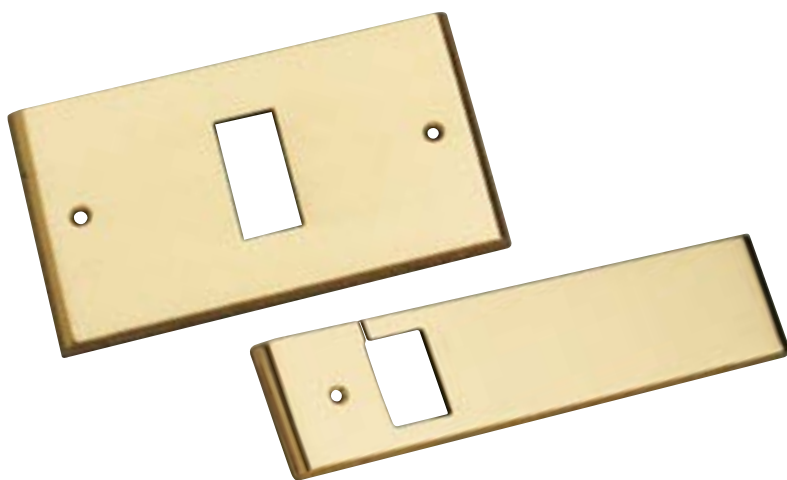

COPRI CIECO  
COVER BLIND  
COPRI INTERRUPTORI 1/2/3 FORI  
1/2/3 HOLE SWITCH COVER  
COPRI INTERRUPTORI 4/5 FORI  
4/5 HOLE SWITCH COVER  
COPRI AVVOLGIBILE  
ROLLER BLIND COVER PLATE

PEZZI	OLV	CRSAT	OBGR
10	9,45	11,97	10,13
10	9,45	11,97	10,13
10	16,38	19,53	17,17
16	12,15	14,15	12,83

**67 B** COPRI INTERRUPTORI BORDO TONDO  
ROUND EDGE SWITCH COVER

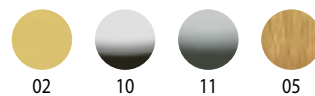
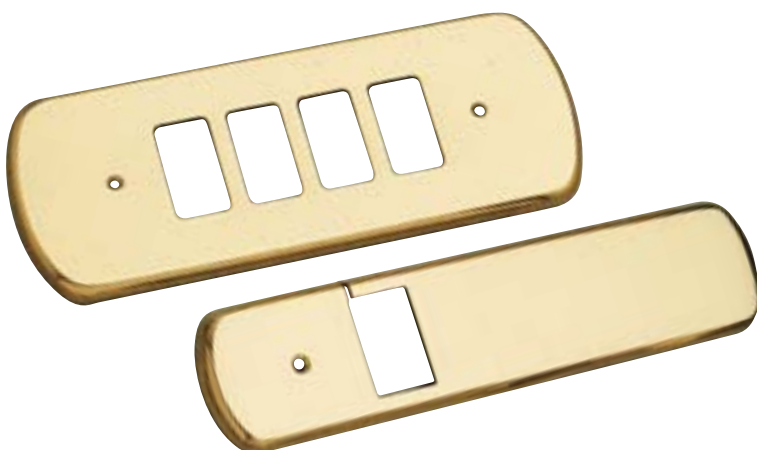

COPRI CIECO  
COVER BLIND  
COPRI INTERRUPTORI 1/2/3 FORI  
1/2/3 HOLE SWITCH COVER  
COPRI INTERRUPTORI 4/5 FORI  
4/5 HOLE SWITCH COVER  
COPRI AVVOLGIBILE  
ROLLER BLIND COVER PLATE

PEZZI	OLV	CRSAT	OBGR
10	11,76	14,28	13,13
10	11,76	14,28	13,13
10	12,15	13,50	13,50
16	16,38	19,53	17,17

**67 C** COPRI INTERRUTORI RETTANGOLARE BORDO TONDO  
 ROUND EDGE RECTANGULAR SWITCH COVER

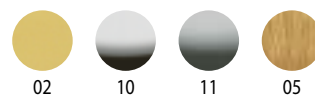

COPRI INTERRUTORI 1/2/3 FORI  
 1/2/3 HOLE SWITCH COVER  
 COPRI AVVOLGIBILE  
 ROLLER BLIND COVER PLATE

PEZZI	OLV	CRSAT	OBGR
10	9,45	11,97	10,13
16	13,50	14,95	14,85

**2004** CAMPANELLO BORDO TONDO CIECO 1 PULSANTE  
 DOORBELL BLIND ROUND EDGE BLIND 1 BUTTON



mm	PEZZI	OLV	BR-ANT
	1	30,00	30,00

**2005** CAMPANELLO BORDO TONDO CON FINESTRA 1 PULSANTE  
 DOORBELL ROUND EDGE BELL WITH WINDOW 1 BUTTON



mm	PEZZI	OLV	BR-ANT
	1	30,00	30,00

**910** CAMPANELLO LEONCINO 1 PULSANTE  
 LION DOORBELL 1 BUTTON

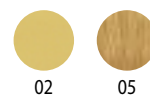

mm	PEZZI	OLV	BR-ANT
	1	22,47	24,30

**2025** NUMERI CON FORI E TASSELLI  
NUMBERS WITH HOLES AND DOWELS



02

mm	PEZZI	OLV
125	10	5,65
75	10	5,65

**2026** NUMERI CON FORI E VITI A VISTA  
NUMBERS WITH HOLES AND EXPOSED SCREWS



02

mm	PEZZI	OLV
125	10	5,80

**2027** NUMERI INGLESII CON FORI  
ENGLISH NUMBERS WITH HOLES



02

mm	PEZZI	OLV
75	10	4,59

**2020** PLACCA MODELLO CAPRI  
PLATE CAPRI MODEL



02

mm	PEZZI	OLV
140X70	5	32,40

**2046** SCRITTA BAGNO TOILETTE  
"TOILETTE" BATHROOM WRITING



02



10



13



05

mm	PEZZI	OLV	OCR	NIK SAT	OBGR
130X40	24	5,20	8,80	7,00	5,80

**2047** SCRITTA BAGNO "FIGURA BIMBO/BIMBA"  
BATHROOM WRITING "FIGURE CHILD /GIRL"



A



B



02



10



13



05

	PEZZI	OLV	OCR	NIK SAT	OBGR
A	24	10,00	12,50	12,00	10,00
B	12	12,00	18,00	18,00	12,00

- A) BIMBA IN TINOZZA - GIRL IN TUB.  
B) COPPIA BIMBO\BIMBA. - COUPLE CHILD \ GIRL.

**1700** SCRITTA BAGNO "FIGURA UOMO"  
*WRITING BATH "FIGURE MAN"*



02

mm	PEZZI	OLV
	24	4,75

**1701** SCRITTA BAGNO "FIGURA DONNA"  
*WRITING BATH "WOMAN FIGURE"*



02

mm	PEZZI	OLV
	24	4,75



**REGGIMENSOLE**  
*brackets*



**2085** REGGIMENSOLA PER MENSOLE IN VETRO FRESATA SPESSORE MAX. 10 mm  
BRACKET FOR MILLED GLASS SHELVES MAX. 10 mm THICKNESS

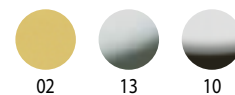

mm	PEZZI	OLV	OCR	CRSAT
Ø 23-10	24	3,78	4,73	5,00

**2088** REGGIMENSOLA A MORSETTO  
BRACKET WITH CLAMP



mm	PEZZI	OL	OCR
15X15	30	2,50	2,70
15X20	30	2,97	3,24
15X25	30	3,11	3,65
15X30	30	3,51	4,05
15X35	30	3,65	4,32

**3499** REGGIMENSOLA IN OTTONE PER MENSOLE IN CRISTALLO SPESSORE MM 8/10  
BRASS BRACKET FOR CRYSTAL MAX THICKNESS 8/10 mm

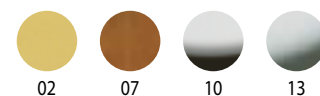

mm	PEZZI	OLV	OBV	OCR	CRSAT	NIK/SAT
20	12	3,36	3,36	3,92	4,09	4,20
40	12	4,36	4,36	5,26	5,46	5,60
60	12	4,97	4,97	5,88	6,02	6,16



**MINUTERIA**  
*small parts*

**230** BORCHIA COPRIDADO OTTAGONALE  
OCTAGONAL NUT COVER STUD

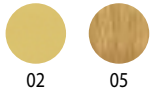

mm	PEZZI	OL	OB
Ø33	24	2,73	2,73

**231** BORCHIA COPRIDADO TONDA  
ROUND NUT COVER STUD

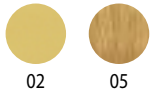

mm	PEZZI	OL	OB
Ø30	24	2,73	2,73

**46** GANCIO DOPPIO  
DOUBLE HOOK

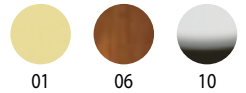

mm	PEZZI	OL	OB	OCR	CRSAT
40X19X50	100	1,37	1,59	1,78	2,09

**47** GANCIO SEMPLICE  
SIMPLE HOOK

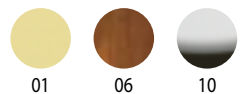
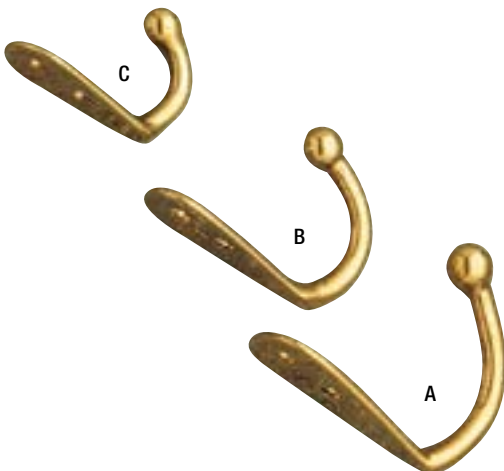

	mm	PEZZI	OL	OB	OCR
A	46X38	100	1,37	1,51	1,63
B	40X30	100	1,08	1,31	1,47
C	34X22	100	0,96	1,21	1,33

**107** GANCIO PER TENDAGGI LEGGERO  
CURTAINS HOOK SLIGHT

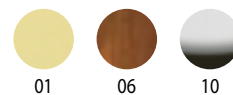
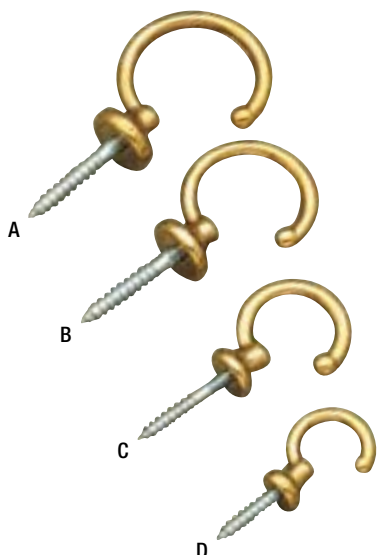

	mm	PEZZI	OL	OB	OCR
A	40X15	100	1,76	1,96	2,21
B	35X14	100	1,56	1,76	2,02
C	30X11	100	1,11	1,26	1,33
D	24X9	100	1,00	1,19	1,22

**89** GANCIO PER TENDAGGI PESANTE  
CURTAINS HOOK HEAVY

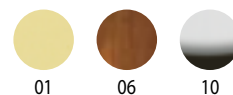
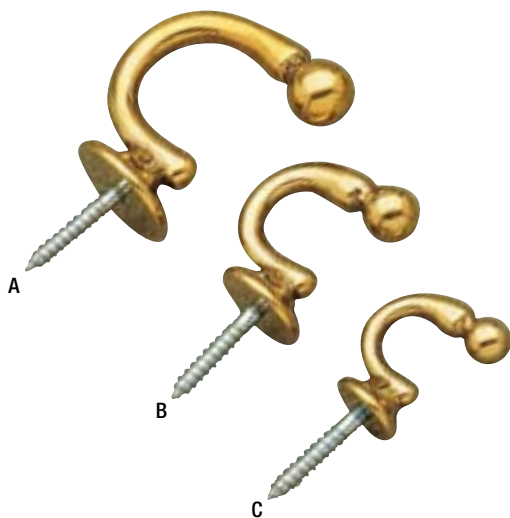

	mm	PEZZI	OL	OB	OCR	CRSAT
A	50X44X25	50	3,21	3,52	3,93	4,13
B	38X33X20	100	2,61	2,82	3,12	3,22
C	33X26X15	100	2,32	2,61	2,82	2,92

**48** GANCIO PER TENDAGGI  
CURTAINS HOOK

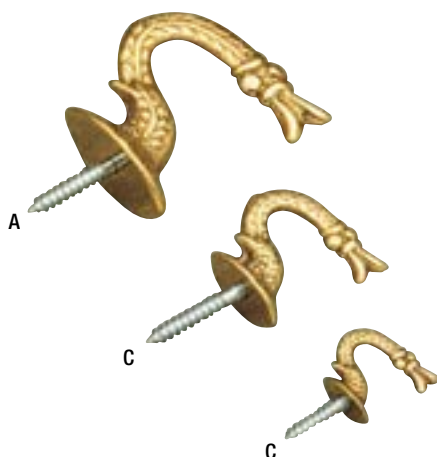

	mm	PEZZI	OL	OB	OCR
A	50x45	50	2,28	2,54	2,76
B	30x30	100	1,56	1,89	2,07
C	22x22	100	1,06	1,33	1,51

**121** GANCIO PER TENDAGGI CON ROSETTA LISCIO  
HOOK FOR CURTAINS WITH SMOOTH ROSETTE



mm	PEZZI	OL	OB	OCR
45X90X65	25	5,17	5,82	6,53

**106** GANCIO PER TENDAGGI CON ROSETTA BAROCCO  
CURTAIN HOOK WITH BAROQUE ROSETTE

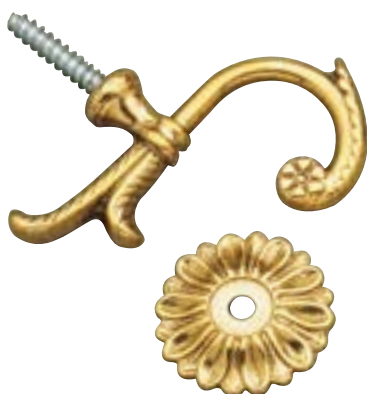

mm	PEZZI	OL	OB	OCR	CRSAT
45X90X65	25	5,04	5,63	6,20	7,20

**49** GANCIO FIORENTINO  
FIORENTINO HOOK

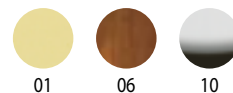
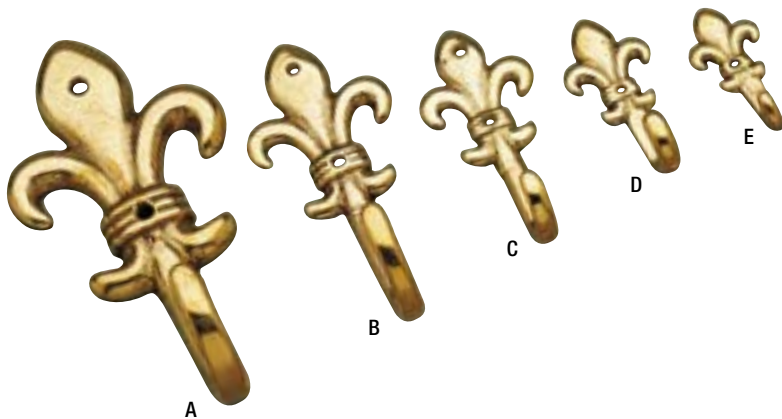

	mm	PEZZI	OL	OB	OCR
A	100X50X38	50	3,82	4,02	4,23
B	75X33X30	100	1,71	1,91	2,21
C	55X25X20	100	1,32	1,72	1,99
D	45X20X17	100	0,86	0,96	1,11
E	33X16X6	100	0,81	0,91	1,02

**116** GANCIO PER QUADRI A CUORE  
HOOK FOR HEART PAINTING

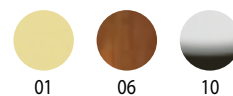
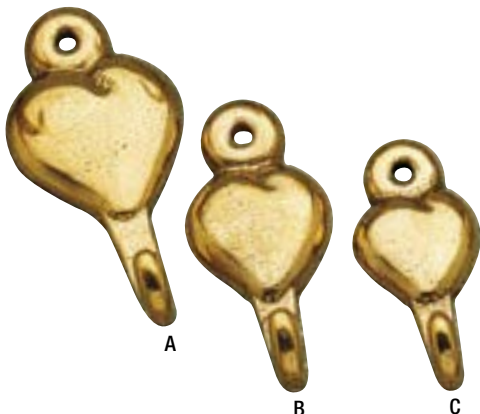

	mm	PEZZI	OL	OB	OCR
A	40X20X6	100	2,33	2,66	2,99
B	35X15X6	100	1,99	2,22	2,66
C	30X14X6	100	1,56	1,77	2,22

**88** GANCIO PER QUADRI BAROCCO  
HOOK FOR BAROQUE PAINTINGS

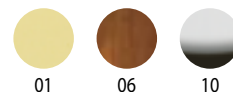
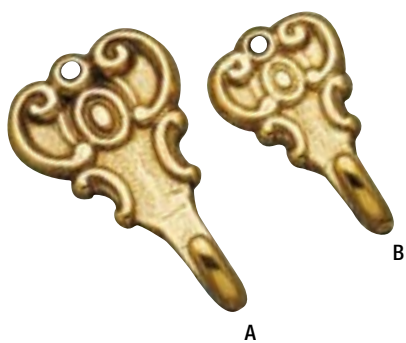

	mm	PEZZI	OL	OB	OCR
A	34X20X7	100	1,22	1,33	1,51
B	16X15X6	100	1,00	1,11	1,39

**185** GANCIO PER QUADRI LUNA  
HOOK FOR MOON PAINTINGS

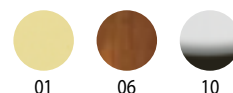

	mm	PEZZI	OL	OB	OCR
A	40X20X6	100	2,33	2,66	2,99
B	35X15X6	100	1,99	2,22	2,66
C	30X14X6	100	1,56	1,77	2,22

**120** GANCIO PER QUADRI QUADRIFOGLIO  
HOOK FOR QUATREFOIL PAINTINGS

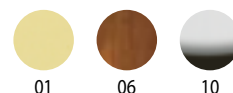
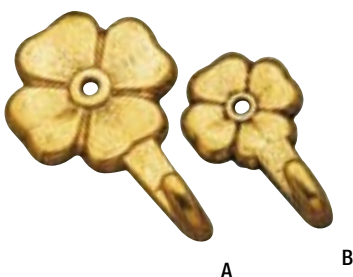

	mm	PEZZI	OL	OB	OCR
A	30X20X6	100	1,62	1,77	2,22
B	26X14X6	100	1,33	1,51	1,69

**121** GANCIO PER QUADRI MARGHERITA  
HOOK FOR DAYSY FLOWER PAINTINGS

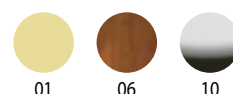
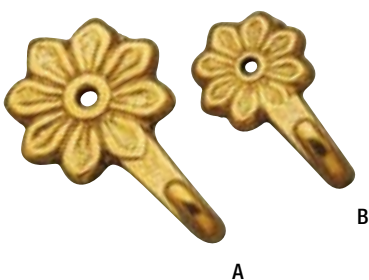

	mm	PEZZI	OL	OB	OCR
A	30X20X6	100	1,62	1,77	2,22
B	26X14X6	100	1,33	1,51	1,69

**122** GANCIO PER QUADRI TULIPANO  
HOOK FOR TULIP PAINTINGS

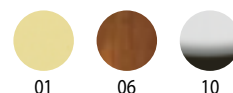
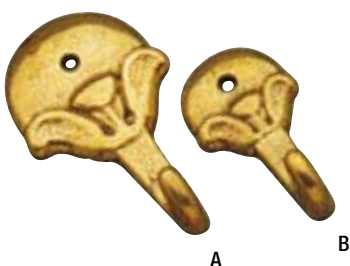

	mm	PEZZI	OL	OB	OCR
A	30X20X6	100	1,62	1,77	2,22
B	26X14X6	100	1,33	1,51	1,69

**302** GANCIO PER QUADRI TRIANGOLO  
HOOK TRIANGLE FOR PAINTINGS

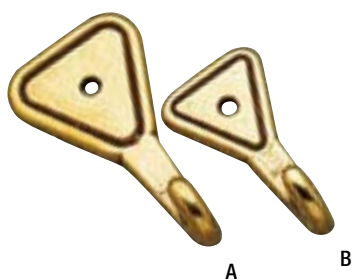

	mm	PEZZI	OL	OB	OCR
A	30X20X6	100	1,62	1,77	2,22
B	26X14X6	100	1,33	1,51	1,69

**303** GANCIO PER QUADRI QUADRATO  
HOOK SQUARE FOR PAINTINGS

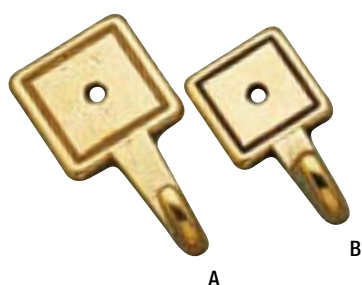

	mm	PEZZI	OL	OB	OCR
A	30X20X6	100	1,62	1,77	2,22
B	26X14X6	100	1,33	1,51	1,69

**304** GANCIO PER QUADRI GOCCIA  
HOOK DROP FOR PAINTINGS

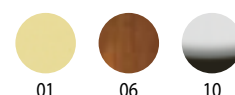
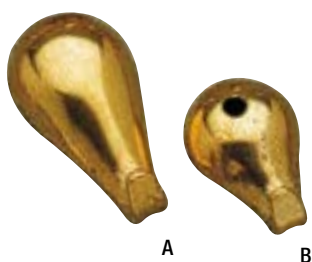

	mm	PEZZI	OL	OB	OCR
A	30X20X6	100	1,62	1,77	2,22
B	26X14X6	100	1,33	1,51	1,69

**407** GANCIO PER QUADRI DOPPIO NODO  
DOUBLE KNOT HOOK FOR PAINTINGS

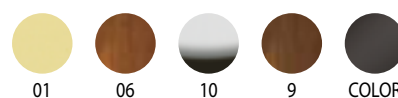

mm	PEZZI	OL	OB	OCR	ANT	COLOR
28X26	100	2,38	2,49	3,00	3,00	3,00

**423** GANCIO PER QUADRI  
HOOK FOR PAINTINGS



mm	PEZZI	OL	OB	OCR	ANT
29X16	100	1,72	1,84	2,43	2,43

**2006** GANCIO PER QUADRI VENTAGLIO  
HOOK FOLDING FAN PAINTINGS

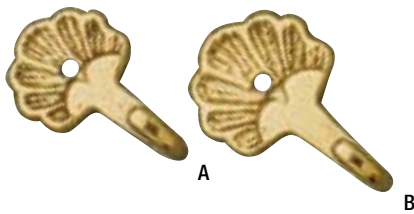

	mm	PEZZI	OL	OB	OCR
A		100	1,62	1,77	2,22
B		100	1,33	1,51	1,69

**2007** GANCIO PER QUADRI FIOCCO  
HOOK TASSEL FOR PAINTINGS

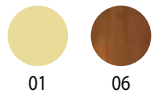

	mm	PEZZI	OL	OB
		100	2,15	2,27

**105** PORTA ABITI MARINA  
MARINA DRESS HOLDER



mm	PEZZI	OLV	OBV	OCR	CRSAT
124X40X60	25	3,00	3,30	3,60	4,50



**911** GANCIO ROSA  
HOOK ROSE



02

mm	PEZZI	OL
95X55X35	24	4,27

**3235** GANCIO RUSTICO  
RUSTIC HOOK



15

mm	PEZZI	F/WERO
60X60	24	5,85

**3238** PORTA ABITO RUSTICO  
RUSTIC DRESS HOLDER



15

mm	PEZZI	F/WERO
125X70	12	9,38

**3249** PORTA ABITO SINGOLO IN ZAMA  
SINGLE DRESS HOLDER IN ZAMAK

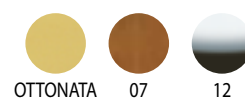

OTTONATA

07

12

mm	PEZZI	Z/ORO	Z/OBV	Z/NIK
108X145	12	9,38	9,38	9,45

**232** COPPIA ASTINE PORTA TENDINE ALLUNGABILI  
PAIR OF EXTENDABLE CURTAIN POLE

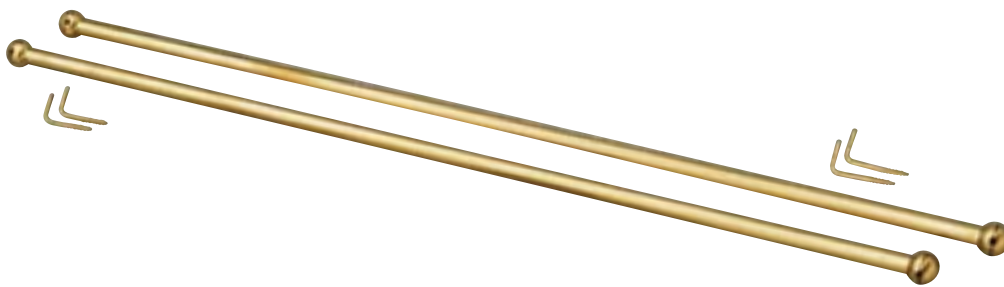

mm	PEZZI	OLV
400-600	24	<b>11,55</b>
600-800	24	<b>13,90</b>
800-1000	24	<b>16,17</b>

**17** SUPPORTI PORTA TENDINE  
CURTAIN HOLDER SUPPORTS

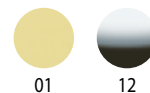

mm	PEZZI	OL	NIK
31X18X11	100	<b>0,56</b>	<b>0,68</b>

**50** MOSCHETTONE  
CARABINER CLIP



mm	PEZZI	OL	OBV	OCR
	50	<b>3,03</b>	<b>3,52</b>	<b>3,70</b>

**24** OCCHIOLI APRIBILI  
OPENABLE EYELETS



mm	PEZZI	OL	OBV	OCR
38X43X10 Ø 13	24	<b>2,80</b>	<b>2,94</b>	<b>3,50</b>
38X43X10 Ø 10	24	<b>2,80</b>	<b>2,94</b>	<b>3,50</b>
38X43X10 Ø 9	24	<b>2,80</b>	<b>2,94</b>	<b>3,50</b>

**2097** EMBRASSE LINEA  
EMBRACE LINEA



02

	mm	PEZZI	OLV	OBV
A	30X30	30	5,00	5,50
B	50X35	30	5,81	6,39
C	80X40	30	7,42	8,16
D	110X45	30	9,17	10,09
E	150X50	30	10,10	11,11

**2098** EMBRASSE LIBERTY  
EMBRACE LIBERTY



02

	mm	PEZZI	OLV	OBV
A	30X30	30	5,00	5,50
B	50X35	30	5,81	6,39
C	80X40	30	7,42	8,16
D	110X45	30	9,17	10,09
E	150X50	30	10,10	11,11

**1182** EMBRASSE LISCIO  
EMBRACE SMOOTH



02

07

10

09

	mm	PEZZI	OLV	OBV	OCR	ANT
A	100X40X8	25	10,69	11,78	12,63	12,63
B	70X40X8	25	10,00	11,09	12,24	12,24
C	50X40X8	25	9,33	10,45	11,06	11,06

**180** SUPPORTO PER TENDAGGI  
SUPPORT FOR CURTAINS



02

	mm	PEZZI	OLV
	70X35 Ø 16	20	19,75
	70X35 Ø 18	20	21,02
	70X35 Ø 20	20	22,31

**2020 B** GANCIO PER TENDAGGI CIGNO  
*HOOK SWAN FOR CURTAIN*



mm	PEZZI	OL	OBV	OCR	CRSAT
55X40X28	50	5,62	6,15	6,37	6,45



**È POSSIBILE AVERE ARTICOLI CON UNA LUNGHEZZA MASSIMA DI 20 CM.  
IN CONFEZIONE SKIN COSTO DELLA CONFEZIONE € 2,00**  
*IT IS POSSIBLE TO HAVE ITEMS WITH A MAXIMUN LENGTH OF 20 cm.  
IN SKIN PACKAGE COST OF PACKAGE € 2,00*

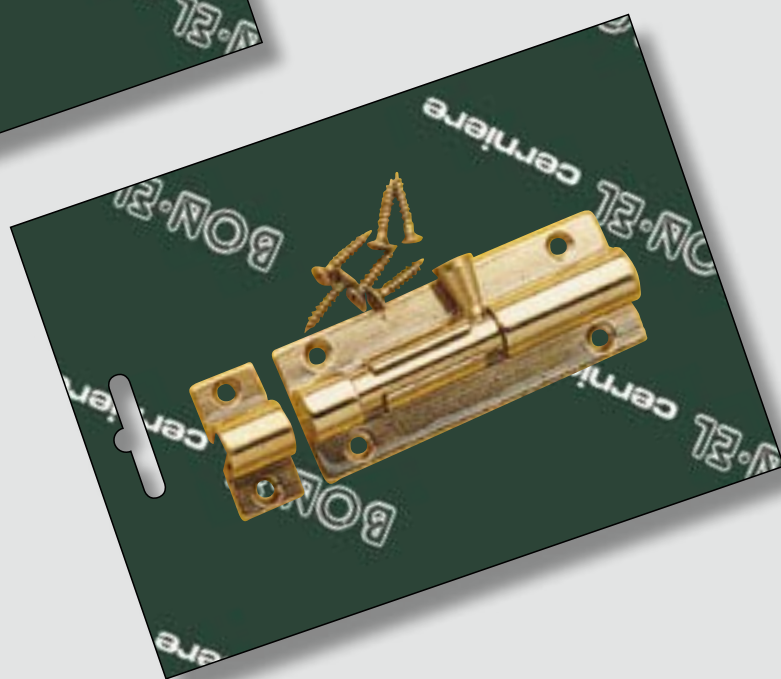
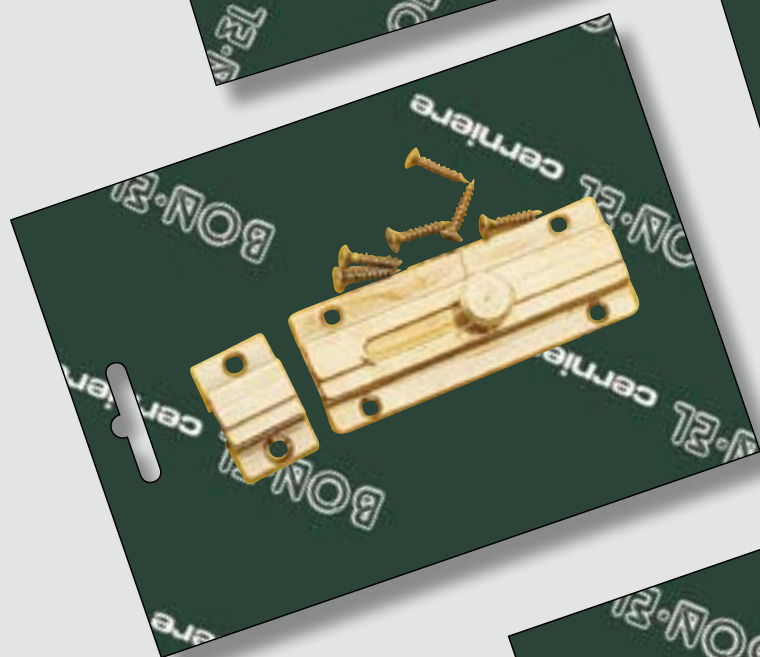

BON-EL

## CONDIZIONI GENERALI DI VENDITA

LE QUOTAZIONI SUL PRESENTE CATALOGO-LISTINO SI INTENDONO IVA ESCLUSA.

---

GLI ORDINI DIRETTI ED INDIRECTI SI INTENDONO SEMPRE VALIDI SALVO APPROVAZIONE DELLA CASA VENDITRICE.

---

GLI IMBALLAGGI VENGONO FATTURATI AL COSTO.

---

TRASPORTO: LE SPESE DI TRASPORTO SONO A CARICO DELL'ACQUIRENTE SALVO PARTICOLARI ACCORDI.

---

LA MERCE VIAGGIA SEMPRE A RISCHIO E PERICOLO DEL COMPRATORE CHE HA L'OBBLIGO DI RITIRARLA. IN CASO DI MANCATO RITIRO TUTTI I DANNI E PERDITE SARANNO A CARICO DEL CLIENTE.

---

I PAGAMENTI DOVRANNO ESSERE FATTI NEI TERMINI CONVENUTI. IL RITARDATO PAGAMENTO DARÀ LUOGO ALLA DECORRENZA DEGLI INTERESSI DI MORA.

---

PER QUALSIASI CONTROVERSIA SARÀ COMPETENTE IL FORO DI BRESCIA.

N.B.: Per una buona conservazione degli articoli verniciati evitare nel modo più assoluto l'uso di sostanze corrosive come: detersivi, lucida-mobili, pulivetro, sidol o altri prodotti similari o sgrassanti.

PASSARE SOLO CON PANNI ASCIUTTI.

I prodotti sopra-descritti per la lucidatura possono essere applicati solo ed unicamente agli articoli in OTTONE LUCIDO NON VERNICIATO.

## GENERAL TERMS OF SALE

*THE QUOTATIONS OF THIS CATALOGUE-PRICE LIST ARE TO BE UNDERSTOOD V.A.T. EXCLUDED.*

---

*THE DIRECT AND INDIRECT ORDERS ARE CONSIDERED ALWAYS VALID, SUBJECT TO APPROVAL OF THE SELLING FIRM.*

---

*PACKAGES ARE ALWAYS BILLED AT COST.*

---

*TRANSPORT: THE FREIGHT COSTS ARE ALWAYS AT CHARGE OF THE BUYER, UNLESS OTHERWISE AGREED.*

---

*GOODS ARE TRANSPORTED AT THE CUSTOMER'S OWN RISK, WHO IS OBLIGED TO COLLECT THEM. SHOULD THE CUSTOMER FAIL TO COLLECT THEM, ALL DAMAGES AND LOSSES WILL BE AT CHARGE OF THE CUSTOMER.*

---

*PAYMENTS MUST BE CARRIED OUT WITHIN THE DEAD-LINE AGREED UPON. A DELAY IN PAYMENT WILL CAUSE DELAY INTERESTS TO START.*

---

*IN CASE OF ANY DISPUTE THE COURT OF COMPETENT JURISDICTION WILL BE THAT OF BRESCIA.*

*P.S.: For a good conservation of the varnished items please avoid absolutely to use corrosive substances such as detergents, alcohol and similar degreasing products.*

*CLEAN THE DOOR-HANDLES ONLY WITH A DRY CLOTH.*

*The production described above for polishing can be applied only and exclusively to items of POLISHED BRASS NOT PAINTED.*

BON-EL

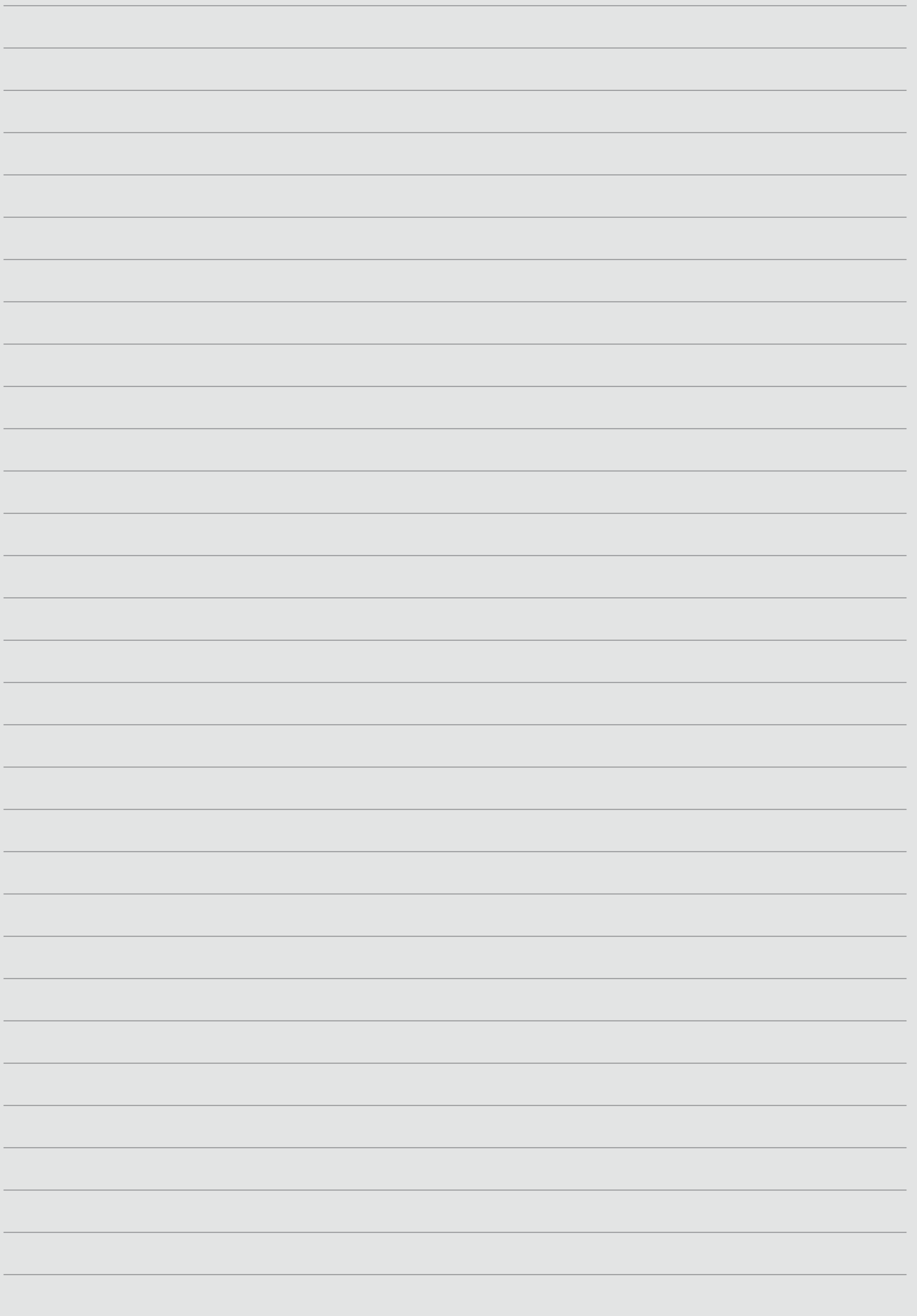



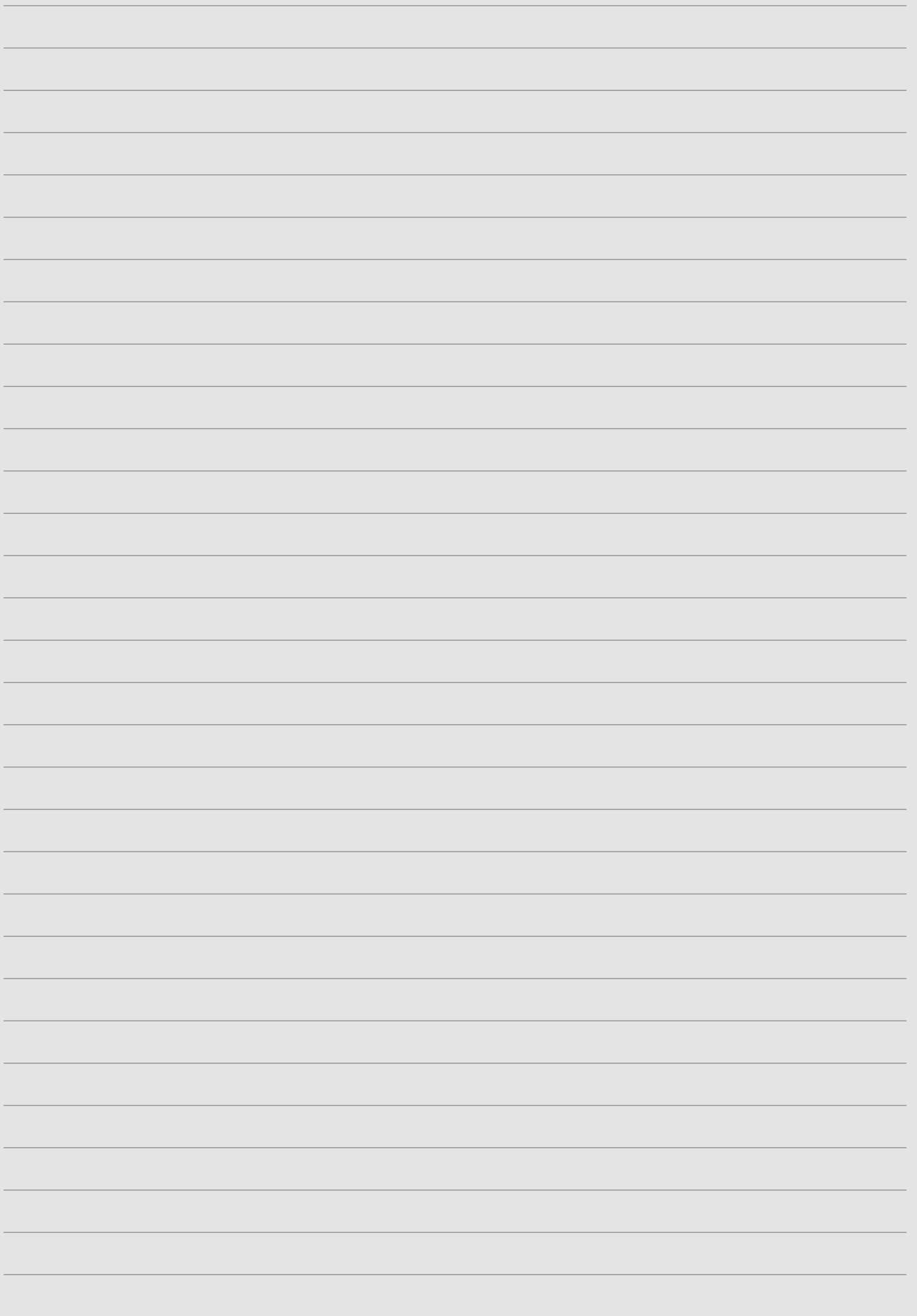

# FINITURE - FINISHING

01 <b>OL</b>	 OTTONE LUCIDO NON VERNICIATO POLISHED BRASS NOT VARNISHED	14 <b>COLOR/BIANCO</b>	 LACCATO BIANCO WHITE LACQUERED
02 <b>OLV</b>	 OTTONE LUCIDO VERNICIATO POLISHED VARNISHED BRASS	15 <b>COLOR/NERO</b>	 LACCATO NERO BLACK LACQUERED
03 <b>OS</b>	 OTTONE SATINATO SATIN BRASS	16 <b>ORO</b>	 PLACCATO ORO 24K GOLD PLATED 24K
04 <b>OSV</b>	 OTTONE SATINATO VERNICIATO SATIN VARNISHED BRASS	17 <b>CF/ORO</b>	 PLACCATO ORO/NIKEL NERO (canna di fucile) GOLD PLATED 24 K / BLACK NIKEL BRASS
05 <b>OBGR</b>	 OTTONE BRONZATO GRAFFIATO SCRATCHED BRONZED BRASS	18 <b>CF</b>	 NIKEL NERO (canna di fucile) BLACK NIKEL BRASS
06 <b>OBR</b>	 OTTONE BRONZATO BRONZED BRASS	19 <b>P/BIA</b>	 PORCELLANA BIANCA WHITE PORCELAIN
07 <b>OBV</b>	 OTTONE BRONZATO VERNICIATO BRONZED BRASS VARNISHED	20 <b>P/CH</b>	 PORCELLANA CHAMPAGNE CHAMPAGNE PORCELAIN
08 <b>OVA</b>	 OTTONE ORO DI VALENZA VALENZA GOLD	21 <b>PDV</b>	 ZIRCONIO PDV PHISICAL VAPOUR DEPOSITION
09 <b>BR/ANT</b>	 OTTONE BRONZO ANTICO ANTIQUE BRONZE BRASS	22 <b>OCR+CR/SAT</b>	 CROMO LUCIDO + CROMO SATINATO POLISHED CHROME + SATIN CHROME
10 <b>OCR</b>	 OTTONE CROMATO POLISHED CHROME	23 <b>O/SAB</b>	 OTTONE SABBBIATO SANDBLASTED BRASS
11 <b>CR/SAT</b>	 OTTONE CROMO SATINATO SATIN CHROME	24 <b>BR/YESTER</b>	 OTTONE BRONZO YESTER YESTER BRONZE
12 <b>NIK</b>	 OTTONE NICHEL NIKEL	25 <b>FER/ANT</b>	 OTTONE FERRO ANTICO ANTIQUE IRON BRASS
13 <b>NIK/SAT</b>	 OTTONE NICHEL SATINATO SATIN NIKEL	26 <b>RAM/ANT</b>	 OTTONE RAME ANTICO ANTIQUE COPPER BRASS



di E. CAINI & C.

25070 Gazzane di Preseglie (BS) - Via Nuova, 15 - Tel. 0365 860373 - Fax 0365 860947

E-mail: [info@bon-el.com](mailto:info@bon-el.com) - Sito internet: [www.bon-el.com](http://www.bon-el.com)